

IUCD Reference Manual for Medical Officers



Family Planning Division
Ministry of Health and Family Welfare
Government of India

July 2007

2007

Ministry of Health & Family Welfare

Government of India, Nirman Bhawan, New Delhi – 110 011

Any part of this document may be reproduced and excerpts from it may be quoted without permission provided the material is distributed free of cost and the source is acknowledged.

First published 1994

Second published 2003

Printing of this updated July 2007 edition for Government of India is supported by USAIDS, New Delhi



भारत सरकार
स्वास्थ्य एवं परिवार कल्याण मंत्रालय
निर्माण भवन, नई दिल्ली - 110011

GOVERNMENT OF INDIA
MINISTRY OF HEALTH & FAMILY WELFARE
NIRMAN BHAVAN, NEW DELHI - 110011

G.C. CHATURVEDI
Joint Secretary
and
Mission Director (NRHM)
Tel.No.23061451

FOREWORD

The Government of India, as part of its commitment towards provision of quality spacing services in Family Planning, introduced CuT380A in 2002 with an effective protection for 10 years replacing the earlier CuT 200. But yet the acceptance of Intra Uterine Contraceptive Device (IUCD) continues to remain below 2%, out of the total Couple Protection Rate of 48.5% for the use of any modern contraceptive method (NHFS-3). One of the objectives of National Population Policy 2000 is to address the unmet needs for contraception. Achieving population stabilization, gender and demographic balance through universal access to equitable, affordable and quality health care, which is responsive to the needs of the people is the objective of the National Rural Health Mission and RCH II launched in 2005. The latest NHFS-3 data shows an unmet need of 6% for spacing methods with a marginal decrease of 1% in the last 7 years.

Some of the major reasons identified for the low acceptance of IUCDs are lack of correct and complete information, both among the providers and acceptors; the advantages are understated, the disadvantages tend to be exaggerated; many myths and misconceptions prevalent in the community and among the providers leading to non acceptance; low insertion skills of the service providers and above all, limited access to skilled service providers. One of the reasons for low knowledge and skills on IUD provision among health providers have also been due to the low priority given to contraceptive skill development of health providers in their basic training. The basic training books of doctors and paramedicals also do not provide detailed information on IUCDs and both knowledge and skill training are mandatory requirements for quality provision of this service.

This "Reference Manual on the IUCD 380 A for the Medical Officers" has been prepared with the objective of bridging this gap in knowledge on IUD 380A and facilitate in repositioning IUCD 380 A in the National Family Welfare Program. Service Medical officers and all medical professionals could use this book not only as manual but also as a reference book on Copper IUCDs. The efforts of the Family Planning Division in the Ministry in developing this manual, which gives an extensive knowledge on IUCD, is commendable.

I hope this manual will go a long way in scaling up the acceptance of IUCDs all over the country.

(G. C. Chaturvedi)
Joint Secretary
and
Mission Director, NRHM



सत्यमेव जयते

भारत सरकार
स्वास्थ्य एवं परिवार कल्याण मंत्रालय
निर्माण भवन, नई दिल्ली - 110011.

Government of India
Ministry of Health & Family Welfare
Nirman Bhavan, New Delhi - 110011

DR. (SMT.) M.S. JAYALAKSHMI

Deputy Commissioner (RSS)

Telefax: 23062485

E-mail : jaya.m@nb.nic.in

jayalakshmidr@rediffmail.com

ACKNOWLEDGEMENT

A Manual on IUCD for Medical officers has been developed as a new initiative from the Government of India, as there has been a great felt need for such a manual from the medical service providers. The manual is a comprehensive book detailing the various aspects of IUCD service provision for a medical officer. This book is an expanded revision on the earlier 'Guidelines on IUCD insertion for Medical Officers', prepared by the division. The book would serve as a reference manual not only for Government service doctors but would also be a valuable reference manual on IUCD for all medical professionals. This has been made possible by the contribution of large number of professionals in this field. Shri Amarjeet Sinha, Joint Secretary in the Ministry has been a constant source of support and encouragement in bringing out this manual. The immense contribution of various experts in going over the manual minutely and repeatedly, though not mentioned individually, is acknowledged with deep gratitude. We are extremely thankful to various international bodies like USAID, JHPIEGO, WHO, UNFPA for their contribution in various forms. The contribution of USAID in printing the manual is deeply appreciated. The existing manual of JHPIEGO on IUD has helped considerably in updating this manual. WHO, UNFPA and Constella Futures have provided continuous technical inputs for which we are thankful to them.

The deepest appreciation goes to Dr.Loveleen Johri, USAID, Dr. S.K. Sikdar, Assist. Commissioner(FP), Dr. Jaya Lalmohan, Consultant, Dr. Sonali Kar, Consultant and Dr.Nidhi Chaudhary ,Constella Futures who have been the backbone in the preparation of the manual. The contribution of Dr. Malviya, Assist Commissioner (FP) is also acknowledged. A special word of appreciation to Dr.Chandrakant, JHPEIGO for his constant support in modifying the manual. Finally I thank Shri Chauhan, Technical Assistant for his secretarial support in preparation of this manual.

Dr. M.S. Jayalakshmi
Deputy commissioner
Family Planning Division

Contents

1. Introduction	1
1.1. Background.....	1
1.2. Global IUCD Usage.....	1
1.3. IUCD use in the National Family Welfare Program of India	2
1.4. Purpose of this Manual	3
1.5. Target Audience	3
2. Overview of IUCD	5
2.1. Basic Information on IUCD.....	5
2.2. Mechanism of Action	7
2.3. Effectiveness	7
2.4. Return to Fertility	8
2.5. Advantages of Copper IUCD 380A	8
2.6. Limitations	9
2.7. Side Effects	9
2.8. Potential Health Risks	9
3. Counseling	11
3.1. Counseling vs. Health education	11
3.2. Counseling vs. Motivation	12
3.3. The Counseling Process	13
4. Medical Eligibility Criteria (MEC)	19
5. Client Assessment	23
5.1. History	23

5.2. Physical Examination	29
6. Insertion and Removal.....	33
6.1. Background	33
6.2. Physical Requirement.....	33
6.2.1. Timing of the Insertion	35
6.2.2. Place of Insertion	35
6.2.3. Appropriate Setting for IUCD services	35
6.2.4. Appropriate Attire for Clients and Staff	36
6.3. Steps in IUCD Insertion	36
6.3.1. Post insertion Assessment	42
6.3.2. Post insertion Education/Counseling	42
6.4. IUCD Removal	44
6.4.1. Before Removing the IUCD	44
6.4.2. Equipments and supplies	45
6.4.3. Steps for IUCD Removal	45
6.4.4. Post Removal counselling	47
7. Infection Prevention	49
7.1. Background	49
7.2. Standard Precautions	50
7.3. Processing of Equipment, Instruments and other reusable Items:.....	51
7.4. Specific Infection Prevention Tips for IUCD Insertion or Removal	54
7.4.1. Before IUCD Insertion or Removal (as Applicable)	54
7.4.2. During IUCD Insertion or Removal (as Applicable)	55
7.4.3. After IUCD Insertion or Removal	55
8. Follow-up care and Management of Potential Problems	57
8.1. Background	57

8.2. Follow-up Visits	57
8.2.1. Follow Up Care	57
8.2.2. Routine Follow-Up Assessment	58
8.3. Management of Problems	59
8.3.1. Menstrual Irregularities	59
8.3.2. Cramps or pain during menstruation	60
8.3.3. Infection	60
8.3.4. String Problems (Possible IUCD Expulsion)	61
8.3.5. Expulsion of IUCD (Partial or Complete)	62
8.3.6. Pregnancy with an IUCD in place	63
8.3.7. Uterine Perforation	63
9. Improving the Quality of IUCD Services	65
9.1. Background	65
9.2. Standards for Quality IUCD Services	65
Annexure	69
Annexure 1: Different types of IUCD	71
Annexure 2: Guidelines for use of IUCDs as emergency contraception	72
Annexure 3: Myths and misconceptions regarding IUCD	75
Annexure 4: Categories Based on the WHO MEC for IUCD Contraceptive Use	77
Annexure 5: Ruling out pregnancy	80
Annexure 6: RTI/STIs: Causative organisms, presenting symptoms and management	81
Annexure 7: Checklist for Screening of Clients	84
Annexure 8: Instruction for loading the IUCD	85
Annexure 9: Key messages for women who have just had an IUCD inserted	90
Annexure 10A: Preparing and Using Chemical Disinfectants	92
Annexure 10B: Making Dilute Chlorine Solution	93

Annexure 10 C: Steps in Processing Instruments, Gloves, and other items used in IUCD Services	94
Annexure 11: IUCD (380 A) follow up card	95
References	96
List of Experts	97

1. Introduction

1.1. Background

India's population, which crossed one billion in 2000, is projected to reach 1.53 billion by 2050, making it the most populous country in the world. Women of reproductive age group (15-49 years) make up approximately 248 million. The Reproductive and Child Health (RCH) Program in India promotes responsible and planned parenthood through the Government's Family Welfare Program with voluntary use and free choice of contraceptive methods.

The current approach in Family Planning emphasizes on offering high quality contraceptive services among eligible clients on a voluntary basis. An important component of the program is promoting adequate spacing of births. The National Population Policy 2000 has recognized as its immediate objective the task of addressing the unmet need for contraception to achieve the medium term objective of bringing the Total Fertility Rate (TFR) to replacement level by 2010 (i.e to reduce the Net Reproductive Rate to 1) so as to achieve the long-term goal of population stabilization by 2045.

As per NFHS –3, the contraceptive prevalence rate in India is 56.3 %, which varies widely among different states and the unmet need for family planning is high at 13% (6% for spacing).

Intrauterine Contraceptive Device (IUCD) is one of the most commonly used reversible methods of contraception among married women of reproductive age worldwide. Results of recent studies and literature have confirmed that IUCDs provide very effective, safe and long-term protection against pregnancy and the health risks associated with the method are negligible too.

1.2. Global IUCD Usage

Recent estimates suggest that almost one in five married contraceptive users are currently using an IUCD because it:

- ◆ Offers highly effective, long-term protection against pregnancy, with prompt return to fertility upon removal;
- ◆ Is convenient—does not require daily action on the part of the user, or repeated clinic visits for supplies (Rivera et al. 2006).

Figure 1.1 Global Use of IUCDs among Women of Reproductive Age.

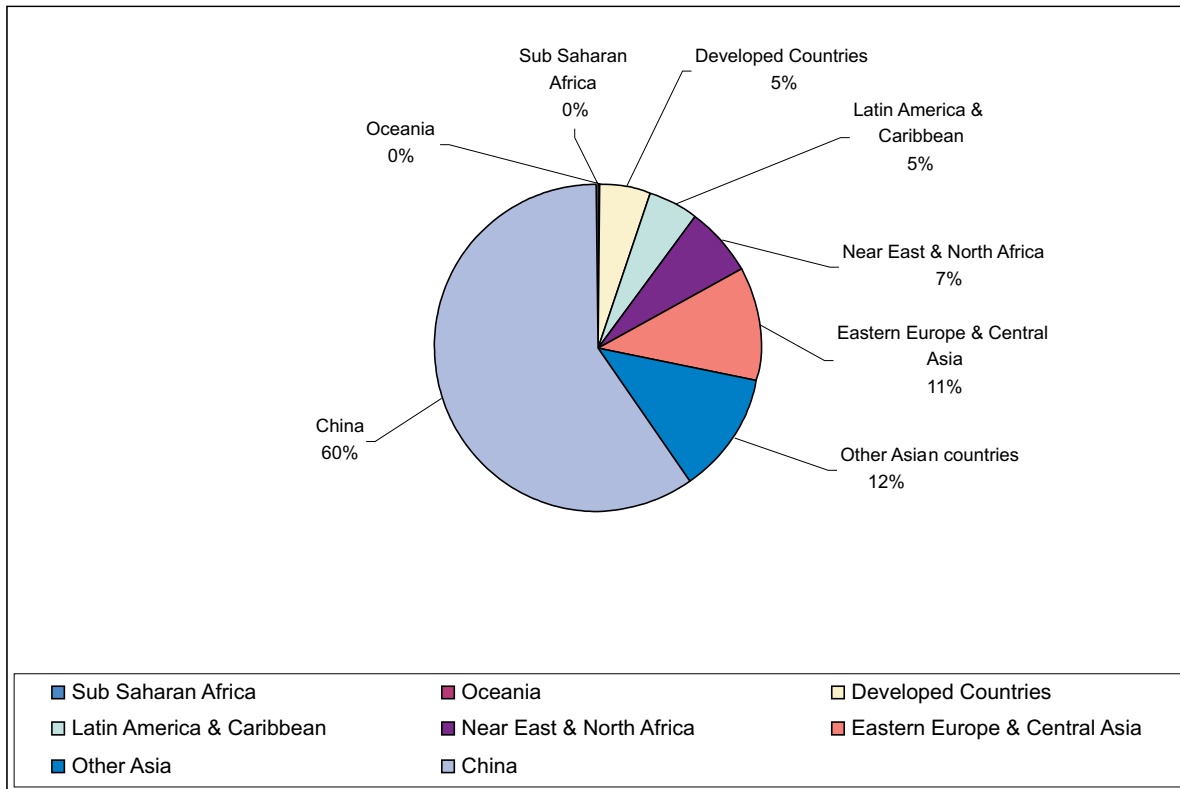

Reference: Data Sources: World Bank, DHS, RHS, United Nations, US Census Bureau's International Database, and other nationally representative surveys

1.3. IUCD use in the National Family Welfare Program of India

IUCDs in the form of Lippes Loop were introduced in the National Family Welfare Program of the Government of India (GOI) in 1965 and has always been considered an important spacing method. Based on the results of clinical trials conducted by the Indian Council of Medical Research in 1972, Copper T 200 B was introduced in the program in 1975. In 1997, ICMR conducted a comparative study between IUCD 200B and 380A based on which CuT 380A was introduced in 2002, replacing CuT 200B in the programme.

In India only 1.8% of married women of reproductive age use IUCDs, though the NFHS-3 has shown an increase in the net CPR to 56.3%. Despite the fact that the government offers IUCD services free of cost, it still remains largely underutilized.

Figure 1.2 CPR contributed by use of any Modern Method (48.5%)

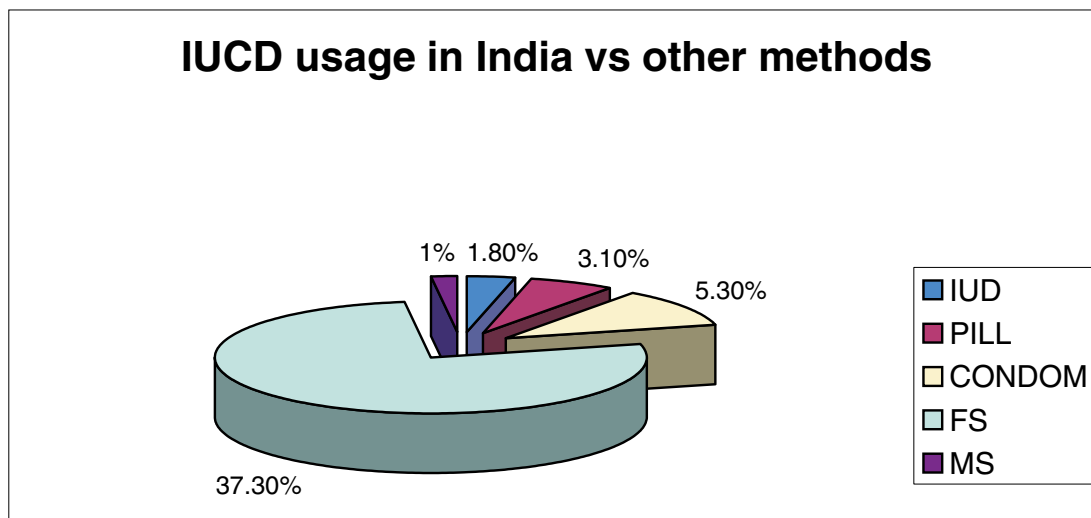

FS-Female Sterilization, MS-Male Sterilization

Reference NFHS-3 (2005-06)

One of the main reasons that IUCD is under utilized in India is that many health service providers and potential clients lack accurate, up to date information about it. It is often found that the advantages are understated, the disadvantages tend to be exaggerated and many myths and misconceptions are prevalent in the community and among the providers. The high discontinuation rate is due to problems related to provider's knowledge and skills leading to improper selection of clients, poor counseling and lack of follow up, all resulting in poor quality of services. There is therefore an urgent need to address these programmatic concerns by improving infrastructure, updating guidelines that include evidence-based practices and increasing the pool of trained providers.

1.4. Purpose of this Manual

This manual seeks to ensure that all providers have the latest information on IUCDs and can provide high quality services that are safe and client centered. It is an attempt to revitalize the training aspect of IUCD services with a long-term plan of repositioning the IUCD in its rightful place in India's Family Welfare Program as a spacing method.

1.5. Target Audience

This training manual is meant for medical officers in developing their knowledge and skills in providing quality IUCD services and thereby increasing its acceptability by eligible couples. This will help to improve the continuation rates and lead to user satisfaction.

2. Overview of IUCD

2.1. Basic Information on IUCD

The first IUCD was developed by Graffenberg in 1909. Subsequently, Jack Lippes developed the Lippes Loop in the 1960s, which became the best known and most widely used IUCD in developing countries. *Currently many different types of IUCDs are being used all over the world. (refer Annexure 1)*

Copper T 380A

The Copper T IUCD 380 A is one of the most widely used IUCDs in the world presently and is available in many countries. It is a T shaped device made of polyethylene and impregnated with barium sulfate for visibility on X-ray. It is 3.6 cm in length and 3.2 cm in width. As shown in Figure 2.1, there are small copper bands on each horizontal arm of the T, which ensure that copper is released high in the fundus of the uterus (Figure 2.2). The “vertical stem” is also wound with copper wire. A thin polyethylene string is attached to the bottom of the stem for easy removal. It is available pre packed with or without a loader (Figure 2.3).

Figure 2.1 Copper T 380A¹

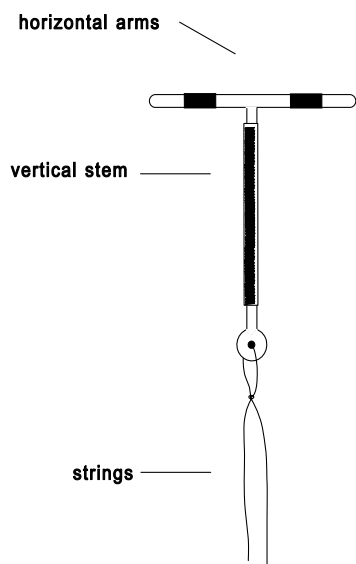
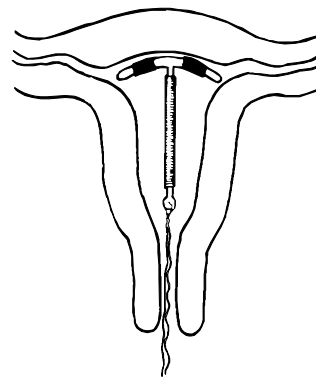
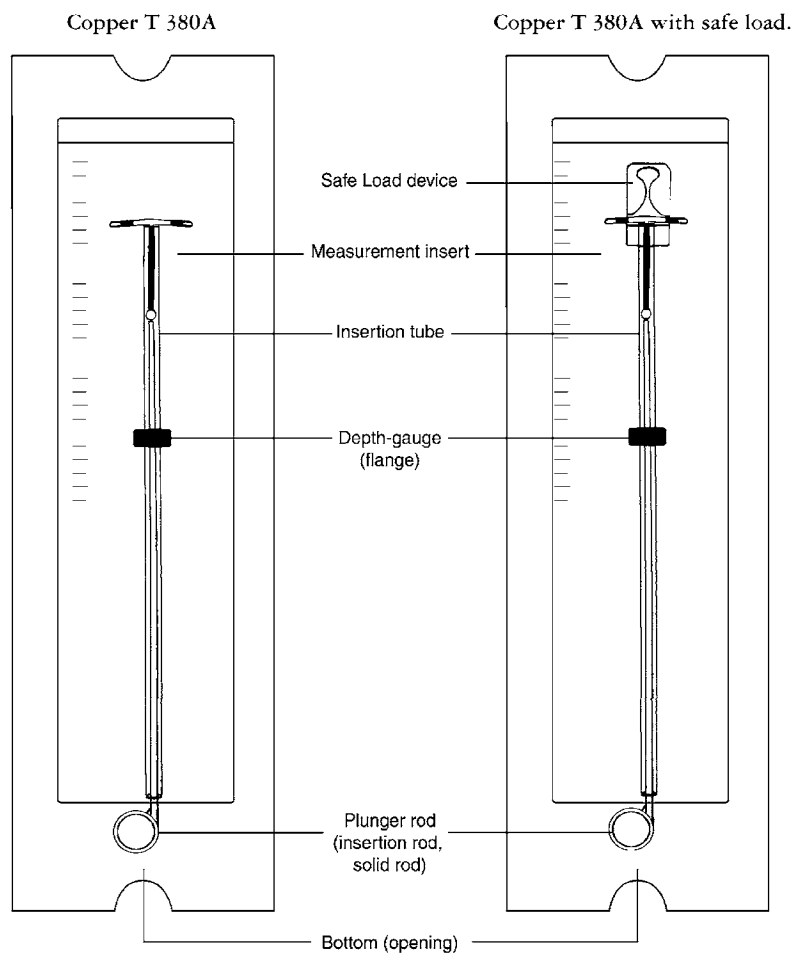

Figure 2.2 Copper T 380A (Inside the Uterus)¹



¹Source: The Population Council and the Program for Appropriate Technology in Health (PATH) 1989.

Figure 2.3



The difference between Copper T 380A and the one with the safe load is only a small device at the top of the package to make loading Copper T in a sterile package easier. However, the information given in the manual applies to both Copper T 380A devices.

Basics of the Copper T 380A without safe load

A working knowledge of the basic structure of the IUCD and its packaging as well as the associated terminology is critical to the provision of quality IUCD services. The insertion assemblies (parts used in insertion) and packaging of the Copper T 380A are presented and labeled in Figure 2.3.

Key terminology is defined as follows:

- ◆ The clear insertion tube is used to guide the loaded IUCD through the cervical os and into the uterus.
- ◆ The white plunger rod (or insertion or solid rod) is held stationary while the insertion tube is pulled back to release the IUCD into the uterus (withdrawal technique).
- ◆ The blue length-gauge (or flange) is used to set the appropriate measurement (i.e., corresponding to the length of the uterus) on the insertion tube, and to ensure that the arms of the T unfold in the proper direction (i.e., along a horizontal plane) once they are released from the insertion tube.
- ◆ The measurement insert is used to set the blue length-gauge to the appropriate measurement on the insertion tube.

2.2. Mechanism of Action

Copper-bearing IUCDs, such as the Copper T 380A, act primarily by preventing fertilization (Rivera et al. 1999). Copper ions decrease sperm motility and function by altering the uterine and tubal fluid environment, thus preventing sperm from reaching the fallopian tubes and fertilizing the egg. The device also stimulates foreign body reaction in the endometrium that releases macrophages and prevents implantation.

2.3. Effectiveness

The IUCD is a highly effective form of long-term, reversible contraception, with an associated failure (pregnancy) rate of less than 1% (0.8%) in the first year of use (Trussell 2004a). In a long-term, international study sponsored by the WHO, the average annual failure rate was 0.4% or less, and the average cumulative failure rate over the course of 12 years was 2.2%, which is comparable to that of tubal sterilization (United Nations Development Programme et al. 1997).

Effective Life: The Government of India is advocating the use of Copper T380 A for upto 10 years and it should be replaced or removed no later than 10 years from the date of insertion.

A Word about Shelf Life

It is important to note that the expiry date on the IUCD package refers only to the shelf life of the sterility of the package and not to the contraceptive effectiveness of the IUCD itself. This means that even if an IUCD is inserted on the day before the expiry date (provided the package is not torn or damaged), it is still effective for the full lifespan of contraceptive efficacy—a full 10 years from that date. On the expiry date the IUCD should be discarded.

2.4. Return to Fertility

A woman's fertility returns promptly after an IUCD is removed (Andersson et al. 1992; Belhadj et al. 1986). This message should be made very clear to clients having an IUCD removed i.e. they should have another IUCD inserted immediately after removal (if desired and appropriate) or immediately start another contraceptive method unless they want to get pregnant.

A Word about Tarnishing

Sometimes the copper on copper-bearing IUCDs tarnishes (i.e., the color darkens), causing concern among providers about the safety and effectiveness of the affected IUCD. All available evidence suggests that tarnished IUCDs are safe and effective and can be inserted and used in the same way as untarnished IUCDs. Therefore, unless the IUCD package is torn or opened (or the shelf life has expired), a tarnished IUCD is still sterile, safe to use and effective.

2.5. Advantages of Copper IUCD 380A

- ◆ Offers long term, highly effective reversible protection against pregnancy
- ◆ Can be used as an alternative to terminal method by couples apprehensive about surgical terminal methods.
- ◆ Is effective immediately after insertion.
- ◆ Can be used by any woman who meets the eligibility criteria for use.
- ◆ Can be used as an emergency contraceptive if inserted within five days of the first act of unprotected sexual intercourse. (*Please refer to Annexure 2*)
- ◆ A new device can be inserted without any gap as many times as the woman desires during her reproductive life.
- ◆ Does not require daily attention from the user or special attention before sexual intercourse.
- ◆ One time procedure and is cost effective
- ◆ Can be used by lactating women
- ◆ Does not interact with any medicines the client may be taking.
- ◆ The woman can reassure herself of the presence of IUCD by feeling for the threads with her washed fingers.
- ◆ Prompt return of fertility after removal.

2.6. Limitations

- ◆ Pelvic examination before IUCD insertion is mandatory as against other spacing methods.
- ◆ Requires a skilled provider for insertion and removal of the device.
- ◆ Does not protect against STIs/ HIV
- ◆ Cannot be inserted in the women who currently have active RTI/STI

2.7. Side Effects

Side effects of IUCD may be unpleasant but are not harmful and in most women these subside or resolve within a few months after insertion. Some women may experience the following:

- ◆ Menstrual changes: There may be increase in the duration/amount of menstrual bleeding or spotting or light bleeding during the first few days or months after insertion. These usually subside with symptomatic treatment.
- ◆ Discomfort or cramps during IUCD insertion and for the next few days which subsides in due course.

2.8. Potential Health Risks

Potential health risks associated with the IUCD, which are uncommon or rare, are discussed below:

- ◆ Uterine perforation during IUCD insertion is a rare complication which occurs in 0.5 to 1.5 per 1000 insertions and is associated with level of provider's skill and experience (Trieman et al 1995). Most perforations are silent and may go undetected. (Penny et al 2004). *(Please refer to chapter 8)*
- ◆ Expulsion is influenced by the skills and experience of the provider and the timing of insertion. Spontaneous expulsion is about 2-8 % (Trieman et al 1995) and is most likely to occur during the first three months after insertion, and during menstrual periods. Nulliparity, heavy menstrual flow and insertion immediately postpartum or after second trimester abortion increases the chances of expulsion (Zhang et al 1992).

- ◆ Infection following IUCD insertion is less than 1%. This minimal risk is highest during the first 20 days after IUCD insertion, *especially if aseptic precautions have not been taken*, rather than due to the IUCD itself. (Hatcher et al 2004)
- ◆ If pregnancy occurs with Copper T in situ, there is a risk of spontaneous abortion, sepsis and ectopic pregnancy; however, IUCD is not found to be having any adverse effects on the fetus.

3. Counseling

Counseling is defined as a helping process where a person (skilled service provider) explicitly and purposefully gives his/her time, attention and skills to assist a client to explore their situation, identify and act upon solutions within the limitations of their given environment.

Counseling is a very essential component of our Family Welfare Services and could concern individuals, couples, families and groups. Here the service provider helps ensure that the clients make free, informed and well-considered decision about their own contraceptive practices, child bearing and spacing.

3.1. Counseling vs. Health education

Though the terms are used interchangeably, they are not the same. They both aim to:

- ◆ Influence behavior
- ◆ Use two-way communication and
- ◆ Rely heavily on communication skills

(Please Refer to Textbox 3.1 and 3.2 for tips on Effective Counseling and Effective Education)

Differences between Counseling and Health Education are:

Counseling	Health education
Coping process where the client is helped to decide or make a choice	Provide factual information about anything.
Initiated by the client seeking the service	Initiated by the educator
Done in one to one situation in very small groups	Dissemination of information in smaller but preferably larger audience

MO at the PHC level can impart Family Planning Health Education during:

- ◆ Village health and nutrition days through ASHAs, AWWs, and ANMs
- ◆ Antenatal and postnatal sessions in the health facilities/ hospitals
- ◆ Post partum visits

3.2. Counseling vs. Motivation

A motivator highlights just the advantages and thus makes the decision for the client while a counselor would talk of both advantages and disadvantages and thus facilitates decision making by the client.

Text box 3.1 Tips to Effective Counseling

An effective counselor:

Focuses on the client's individual needs and circumstances.

Helps the client make her own decisions (does not make them for her).

Uses good communication skills throughout.

Listens attentively to what the client has to say, using nonverbal gestures, such as nodding, to further encourage her.

Asks the client open-ended questions that require more than "yes" or "no" answers to increase the amount of information provided.

Encourages the client to ask questions and express her opinions, desires and concerns. Maintains a friendly tone of voice.

Is patient and never forces the client to finish speaking.

Maintains eye contact with the client.

Text Box 3.2 Tips for conducting effective group education sessions.

Setting up:

Choose a quiet place with enough space. Avoid places where many people are coming and going.

Limit groups to 15 people or fewer if possible.

Seat group members in a circle and sit with them.

Getting started:

Introduce yourself and have group members introduce themselves.

Explain the topic and overall purpose of the discussion.

Help group members feel at ease, perhaps by asking general questions. It helps if you are relaxed as well.

Start the discussion by presenting clear information. For example, if the purpose of the session is to discuss family planning methods, list them and briefly describe each one.

Throughout:

Use words that everyone in the group can understand.

Show samples of family planning supplies when you talk about them. Let group members hold them and look at them.

Use flipcharts, diagrams, or posters to help illustrate important points.

Summarize important points often.

Ask questions frequently to keep group members involved in the discussion. Encourage them to ask questions as well, and to discuss their answers with each other.

Wrapping up:

Ask for any additional questions.

Summarize important points.

3.3. The Counseling Process

Counseling is not an isolated event but an ongoing process that should be part of every interaction with the client. Family planning counseling can be divided into three phases:

- ◆ **General family planning counseling** (during the initial contact with the client): the client is provided basic information on a range of methods and assisted in choosing a method that is appropriate for her;
- ◆ **Method-specific counseling** (prior to and immediately following provision of the method chosen): the client is provided more detailed information about the method, as well as instructions on how to use it safely and effectively; and
- ◆ **Follow-up counseling** (during return visits): the client's satisfaction with the method is assessed, and any problems or concerns are discussed.

Counseling and communication techniques

This helps ensure that service providers are able to provide effective counseling. This section presents some tips for providing quality counseling to family planning clients—highlighting skills, practices, and attitudes that are characteristic of an effective counselor.

An effective counselor understands the benefits of counseling and is willing to take the time to do it right.

The **GATHER** technique is one method used to organize the elements of the counseling process. This acronym is designed to help staff remember important points in an effective counseling session. GATHER is one approach to counseling; in practice, counseling should be tailored to the woman's individual needs and circumstances and thus may follow a different sequence or require other techniques.

GATHER means:

- G** Greet
- A** Ask
- T** Tell
- H** Help
- E** Explain
- R** Return visit/Refer

The GATHER technique is outlined in Table 3.1. Points that are specific to or especially relevant to potential IUCD clients are highlighted.

Table 3-1 The GATHER Technique

STEPS	POINTS OF DISCUSSION/ACTIVITIES	RATIONALE
GREET the woman	<ul style="list-style-type: none"> ◆ Greet the woman with warmth and respect ◆ Ask why she has come and what she hopes to get out of the session. ◆ Make sure she understands that you are here to help her choose a family planning method that is right for her (not choose one for her). ◆ Encourage her to talk and ask questions. ◆ Make clear that you want to listen. ◆ Explain that you need her to speak openly about some private/personal matters so that you can help. ◆ Assure her that the meeting will be confidential. 	<p>Sets a positive tone</p> <p>Clarifies expectations and roles</p> <p>Lays the foundation for a productive counseling session</p>
ASK her about herself	<ul style="list-style-type: none"> ◆ Ask about any previous experiences with family planning (methods used, reason for discontinuing, etc.). ◆ Assess partner/family attitudes about family planning (whether she has discussed this with them, whether they are supportive, etc.). ◆ Ask about her reproductive goals (how many children she wants, desire for birth spacing, desire for long-term protection against conception, etc.). ◆ Ask about her need for protection against STIs (<i>please refer to Textbox 4.1</i>). ◆ Ask whether she is interested in a particular family planning method. <p>Important: Explain that all sexually active persons should consider their individual risk for HIV and other STIs, and whether they should use condoms, alone or along with another method, for protection.</p>	<p>Provides information you need to assist her in choosing a suitable method</p> <p>Shows client that her needs and desires are important</p>

STEPS	POINTS OF DISCUSSION/ACTIVITIES	RATIONALE
TELL her about family planning	<p>Tip: Use support materials such as diagrams, brochures, and actual samples of different methods to emphasize and illustrate points. Encourage the woman to handle the materials. Handling a sample IUCD may be especially important, as many women may be surprised to see how small it is.</p> <ul style="list-style-type: none"> ◆ Provide general information about family planning, focusing on the method in which the woman is interested (if any) and any other methods that may be appropriate. Information covered may include: <ul style="list-style-type: none"> Effectiveness of the method Mechanism of action Side effects Health benefits and potential risks Protection from HIV and other STIs Cost and convenience Accessibility/availability of supplies needed Whatever else may be relevant to the client ◆ Correct any misconceptions the woman may have about the method(s) she is considering. (Ask whether she has any concerns about the method, what she has heard, etc.) <p>Tip: Tailor information to the woman's desires, as well as to her individual needs and situation-based on what you have learnt.</p> <p><i>For guidance on correcting common myths and misconceptions about the IUCD, see Annexure 3.</i></p>	Provides information she needs to make an informed decision about which method is suitable for her

STEPS	POINTS OF DISCUSSION/ACTIVITIES	RATIONALE
<p>HELP her select a method</p>	<ul style="list-style-type: none"> ◆ Help the woman choose a method. Do not decide for her. ◆ Assess her knowledge about the selected method by having her repeat key details back to you, and by asking her questions. For potential IUCD users, it is especially important that they understand that: <ul style="list-style-type: none"> ◆ Menstrual bleeding pattern changes are a common side effect associated with the method. ◆ The IUCD offers no protection against HIV or other STIs; clients who are at risk should also use condoms for protection. ◆ Encourage her to ask questions and state any remaining concerns about the selected method. ◆ After a method is selected, the client will undergo the appropriate medical assessment to ensure that there are no medical reasons why she should not use the method. Potential IUCD users should know that this will involve a pelvic examination to screen for possible STIs and other conditions. ◆ Once the appropriate medical assessment is completed, the chosen contraceptive method is provided, if appropriate. A potential IUCD user should know that this will involve a minor procedure to insert the IUCD into her uterus. ◆ Immediately before the IUCD insertion procedure, the client should receive preinsertion counseling. 	<p>Helps the woman consider the method(s) discussed in terms of her own needs and circumstances</p> <p>Alerts the potential IUCD user to aspects of the method that may be of concern to some women</p> <p>Prepares the potential IUCD user for the medical assessment and IUCD insertion procedure</p>

STEPS	POINTS OF DISCUSSION/ACTIVITIES	RATIONALE
EXPLAIN how to use the method	<p>Immediately after the IUCD is inserted the client should receive post insertion instructions (Please refer 6.3.2).</p> <p>Explain how to use the method, what to do if she experiences any problems or side effects, and provide any other basic information needed. For IUCD users, special emphasis should be given to menstrual bleeding changes, and the need for condoms to protect against STIs.</p> <p>Provide information on warning signs that indicate the need to return to the clinic immediately. For IUCD users, symptoms of infection, expulsion, and pregnancy are among such warning signs.</p> <p>Provide specific return visit instructions. Be sure the woman knows where to go if she has problems, or whom to contact if she has questions. IUCD users should have a routine checkup after their first menstruation (in 3 to 6 weeks).</p> <ul style="list-style-type: none"> • Ask the client to repeat all instructions. • Encourage her to ask questions and state any remaining concerns. • Provide additional information and reassurance as needed. 	Provides information she needs to use the method safely and effectively
RETURN VISIT/ REFER	<ul style="list-style-type: none"> • Assess client satisfaction. • Check for concerns or problems. For IUCD users, emphasis is placed on menstrual bleeding changes, use of condoms to protect against STIs, and warning signs. (They also have a pelvic examination to check for infection and expulsion.) • Reinforce client instructions for use of the selected method. • Provide appropriate follow-up for any problems identified. • Refer the woman if needed. 	Provides information she needs to continue using the method safely and effectively or discontinue using, as appropriate

4. Medical Eligibility Criteria (MEC)

Medical eligibility criteria address contraceptive use by people with specific medical conditions and people with special needs. Decisions on appropriate contraception must take into account the expressed desires of the individual and the nature of the method. Decisions must be based on informed choice. The reproductive rights of the individual must be considered in any such decisions. To provide quality care in IUCD services it is essential for the provider to screen the clients based on the MEC.

In the WHO system, a woman's eligibility for using a specific method falls into one of four categories, depending on the presence/absence of various condition(s) based on the *WHO MEC 2004* (please see Annexure 4). The categories which have been adapted as per the Indian scenario are as follows:

CATEGORY 1: *Can use the IUCD with no restrictions.* Women with conditions that fall into this category include, but are not limited to, the following:

- ◆ Women having Lactational Amenorrhea after reasonably excluding pregnancy
- ◆ Post menstrual insertion any time in the cycle after reasonably excluding pregnancy.
(See Annexure 4 for details)
- ◆ Immediately following a first-trimester abortion (spontaneous or induced).
- ◆ More than 6 weeks postpartum provided there is no evidence of infection.
- ◆ Benign ovarian tumors (or cysts) or uterine fibroids that do not distort the uterine cavity.
- ◆ Genital infections with mild nonpurulent discharge to be inserted and treated simultaneously (e.g. bacterial vaginosis, candida albicans, trichomoniasis).
(Please See Annexure 6 on Diagnosis and Management of vaginal genital infection)
- ◆ History of Pelvic Inflammatory Disease (PID) with a subsequent pregnancy (assuming there are no known current risks for STIs,
 - * Women who have breast disease, including breast cancer.
 - * Viral hepatitis or malaria.
 - * Controlled diabetes, hypertension or “uncomplicated” valvular heart disease.
 - * Women who smoke or are obese.
- ◆ Women with a history of ectopic pregnancy
- ◆ As emergency contraception

CATEGORY 2: *Can generally use the IUCD (the advantages generally outweigh the risks, although additional care/follow-up will be needed):*

- ◆ Less than 20 years of age (and nulliparous) or are nulliparous, as there is a slightly greater risk of expulsion due to the smaller size of the uterus.
- ◆ Immediately following a second-trimester abortion (spontaneous or induced), provided there is no evidence of infection. However, the IUCD should be inserted only by a specially trained provider (because of the increased risk of expulsion).
- ◆ Less than 48 hours postpartum provided there is no evidence of infection. However, the IUCD should be inserted only by a provider specially trained in post partum insertion of IUCD (because of the increased risk of expulsion).
- ◆ Have anatomical abnormalities of the reproductive tract that do not distort the uterine cavity in a way that might interfere with IUCD insertion or placement (e.g., cervical stenosis).
- ◆ Are at risk for STIs other than Gonorrhoea or Chlamydia (e.g., HIV, herpes, syphilis, hepatitis).
- ◆ Genital infection with severe nonpurulent discharge (e.g., herpes, syphilis, and trichomoniasis) should be treated, reviewed and then inserted (*Please see Annexure 6 for diagnosis and management.*)
- ◆ Have a past history of PID without a subsequent pregnancy (assuming there are no known current risk factors for STIs).
- ◆ Women who are HIV-infected and are clinically well.
- ◆ Women who have AIDS, are on ARV (antiretroviral therapy) therapy, and are clinically well. (*Please refer to Text box 4.1*)
- ◆ Have complicated valvular heart disease (e.g., artificial shunts, rheumatic heart disease), although prophylactic antibiotics are advised for IUCD insertion to prevent endocarditis.
- ◆ With anemia (including thalassemia, sickle cell disease and iron-deficiency anemia), although there is some concern about increased menstrual blood loss with copper-bearing IUCDs *and thus in these conditions iron supplements should be given.*
- ◆ *Those with 1st and 2nd degree uterine prolapse*
- ◆ *Those with Rectovaginal fistula*

Important: IUCD does not provide protection against HIV and other STIs; those at risk should be encouraged to use condoms.

CATEGORY 3: *Use of the IUCD is not recommended for women with the following* (the risks generally outweigh the advantages); they should use a different method unless no other method is available or acceptable:

- ◆ *Heavy/prolonged or painful menstruation, endometriosis, or severe dysmenorrhea, may wish to consider another family planning method, as heavier menstrual bleeding and cramping are common effects of the IUCD.*
- ◆ 48 hours to less than 6 weeks postpartum.
- ◆ Benign trophoblastic disease.
- ◆ Ovarian cancer (although they are Category 2 for continuation).
- ◆ Have a high individual risk for gonorrhoea or Chlamydia having purulent cervical discharge (although they are Category 2 for continuation).
- ◆ Have AIDS but are not on ARV therapy (although they are Category 2 for continuation). *(Please refer to Text box 4.2)*
- ◆ *Those with 3rd degree uterine prolapse .*
- ◆ *Those with Vesicovaginal fistulas*

CATEGORY 4: *Should not use the IUCD:*

- ◆ Who are pregnant.
- ◆ Have history of infection or signs/symptoms of infection within 6 weeks postpartum (puerperal sepsis), or immediately following an abortion (immediate post-septic abortion).
- ◆ With malignant trophoblastic disease.
- ◆ With cervical or endometrial/uterine cancer (although they are Category 2 for continuation while awaiting evaluation).
- ◆ Have anatomical abnormalities of the reproductive tract or uterine fibroids that distort the uterine cavity in a way that interfere with IUCD insertion or placement.
- ◆ Have pelvic tuberculosis.
- ◆ Unexplained vaginal bleeding (although they are Category 2 for continuation while awaiting evaluation).
- ◆ Have current PID, purulent cervicitis, Chlamydia, or gonorrhoea (although they are Category 2 for continuation while awaiting evaluation or undergoing treatment.)

The conditions in italics are adaptations made according to the Indian Scenario

MOs at the PHC level should insert IUCD only for conditions in Category I and II. Category III may be referred to a gynecologist.

Text box 4.1 *If the woman has HIV*

The IUCD can generally be used in this situation, provided that the woman is clinically well, with access to adequate care. Additional care/follow-up may be needed because the IUCD provides no protection against HIV reinfection or other STIs.

What to do:

Assess whether she is clinically well (e.g., has not been feeling ill, has not been diagnosed with AIDS) and has access to adequate care. If she is clinically well with access to adequate care: **If YES:**

Additional support and care (as appropriate after IUCD insertion):

Continue to urge use of condoms

Text box 4.2 *If the woman has AIDS*

The IUCD often can generally be used in this situation, provided that the woman is on ARV therapy and is clinically well, with access to adequate care. Additional care/follow-up may be needed because the IUCD provides no protection against HIV reinfection or other STIs.

What to do:

Assess whether she is on ARV therapy and is clinically well (e.g., has not been feeling ill, does not have opportunistic infections) and has access to adequate care.

If she is on ARV therapy and is clinically well, with access to adequate care:

Remind her that the IUCD offers no protection against STIs or HIV reinfection.

Urge her to use condoms in addition to the IUCD.

If she is not on ARV therapy (regardless of whether she is clinically well or has access to care), advise her that the IUCD is not recommended for women in this situation. Help her choose a different method.

Additional support and care (as appropriate after IUCD insertion): Continue to urge use of condoms. Be alert for signs/ symptoms of pelvic infection and other problems.

5. Client Assessment

Careful client assessment is necessary to provide quality health care and family planning services. This chapter focuses on identifying characteristics and conditions that may affect a woman's eligibility for Cu T 380A use.

Key objectives of assessment of potential IUCD clients are to:

- ◆ Ensure that the woman is not pregnant
- ◆ Determine the length and direction of uterus (for IUCD insertion)
- ◆ Ensure that she does not have Gonorrhoea and Chlamydia, and is not at a high individual risk of these STIs
- ◆ Identify other characteristics or conditions that may affect her eligibility for IUCD use
- ◆ Identify any other problems that may require further assessment or treatment

5.1. History

The table below is designed to help the MO make his/ her decision about the client's eligibility for IUCD. It could be grouped into the following categories of history taking:

- ◆ Contraceptive history
- ◆ Menstrual history
- ◆ Obstetric history
- ◆ Reproductive/ sexual history
- ◆ Medical history (general)

QUESTION	RESPONSE	COMMENTS
Contraceptive History		
Ask about past experience with family planning, desire for spacing, or long-term contraception.	Yes	Potential IUCD client
	No	Consider the woman's need for family planning education and counseling

Ask about last method used and enlist causes of discontinuation	No	Potential IUCD client
	Yes	Ask reasons for discontinuation
Any history of use or expulsion of IUCD	No	Potential IUCD client
	Yes	Ask for her experience. If she had discontinued, ask specifically for reasons for discontinuation like pain/bleeding/expulsion. Refer or Insert with caution with appropriate follow up
Menstrual history		
Are you currently menstruating	Yes	Potential IUCD client
	No	Rule out the possibility that the woman is pregnant. Inserting IUCD during pregnancy can cause serious uterine infection and spontaneous septic abortion.
Are your menstrual periods very long or heavy, or associated with pain/cramping?	No	Potential IUCD client
	Yes	<ul style="list-style-type: none"> ◆ Ensure that the woman understands that menstrual changes can occur among IUCD users, especially in the first few months ◆ Advise her that use of an NSAID (such as ibuprofen) can help ◆ If she seems very concerned about the side effects, counsel her on contraceptive methods that may be more appropriate (such as hormonal methods). <p>Insert with caution</p>
Obstetric history		
Do you have a missed period	No	Potential IUCD client
	Yes	It could be a pregnancy, so the MO should be reasonably sure to rule out pregnancy (<i>Please see Annexure 5</i>)

Have you ever given birth before?	Yes	Potential IUCD client
	No (Nulliparous)	Insert with caution In such cases there is an increased risk for IUCD expulsion if her uterus is less than 6.5 cm in length (to be determined during uterine sounding, which is done later in the process).
If client is in postpartum period ask the following questions: A. Has your delivery been post 48 hours to 6 weeks ago?	Yes	The IUCD should not be inserted at this time. <i>Note that the IUCD can generally be inserted within 48 hours of birth, provided there is no evidence of infection; but this procedure should be performed only by a specially trained provider.</i>
	No (post 6 weeks)	Potential IUCD client
B. Are you more than 6 weeks postpartum and exclusively breastfeeding, and have you not begun menstruating again?	No	Unless it can be reliably determined that the woman is not pregnant, advise the woman to await menses to ensure that she is not pregnant before returning to the clinic for possible IUCD insertion. Provide a back-up method for her to use during the interim.
	Yes	Potential IUCD client
C. Do you have symptoms of infection (such as fever, chills, abnormal discharge) within 6 weeks of current delivery or following abortion	No	Potential IUCD client
	Yes	The IUCD should not be inserted at this time as it may substantially worsen puerperal sepsis or post abortion sepsis. ALSO Conduct further evaluation and provide appropriate treatment of the infection according to national guidelines/local protocols (refer if needed). Strongly recommend the use of condoms while undergoing treatment
D. Was the last delivery by LSCS.	No	Potential IUCD client
	Yes	IUCD insertion can be done by a MO after 6 weeks of the LSCS but with caution*

History of any current abortion	No	Potential IUCD client
Did you have a miscarriage or abortion within the last 4 weeks?	Yes	Can be inserted immediately following (or within 7 days of) a first-trimester spontaneous or induced abortion, provided there is no evidence of infection. If immediately following a second-trimester abortion, insert with caution.
Relevant gynecological history		
Have you recently had, either of the following?	No	Potential IUCD client
<ul style="list-style-type: none"> ◆ Vaginal bleeding that is unusual for you (e.g., between your periods) ◆ Vaginal bleeding that occurs after intercourse 	Yes	The IUCD should not be inserted. Also advise the woman that further evaluation is needed to find the cause of her symptoms, REFER Urge the use of condoms in the interim, or provide another back-up method.
Have you recently had, either of the following:	No	Potential IUCD client
<ul style="list-style-type: none"> • Lower abdominal pain (that may be worse during/after intercourse or when walking), accompanied by fever or chills <p>*Abnormal vaginal discharge that may contain pus</p>	Yes	These symptoms may indicate PID/STI Screen the woman carefully and in case of current infection, REFER (Refer Text box 5.1)
If abnormal gynaecological history elicited, try taking a sexual history		

Have you had any of the following in the last 3 Months: <ul style="list-style-type: none"> • Symptoms of RTI/STI • More than one sexual partner (without consistently using condoms) • Has ANY OF YOUR partner/ spouse had STI in past 3 Months. 	No	Potential IUCD client
	Yes	Presence of any of these factors suggests that the woman is at “very high individual risk” for current infection with STI and IUCD could enhance chances of repeat PID; Advise the woman that IUCD insertion can be reconsidered once current STI have been reliably ruled out or successfully treated. <i>(Please refer to Text box 5.1 and Annexure 6 for diagnostic guidelines)</i>
General Medical history		
Any generalized complaints like fatigue, weakness, dizziness, headache, ringing in ears, sore tongue, irritability	No	Potential IUCD client
	Yes	Insert with caution * and additional care/follow-up may be needed for management of anaemia
Have you been told you have a heart disease or a condition that affects your heart valves?	No	Potential IUCD client
	Yes	Insert with caution * for uncomplicated heart disease with antibiotic cover Contraindicated for complicated/symptomatic valvular heart disease.
Have you had any pelvic surgery/ Cancer of your reproductive organs/ TB of reproductive organs or vesicular mole	No	Potential IUCD client
	Yes	Refer to a specialist for IUCD insertion if needed.

- ◆ *In cases where the MO is advised to proceed with IUCD insertion with caution, the MO should feel competent enough to do the procedure and in case of slightest of doubts should refer the woman to a gynecologist.*

**Textbox 5-1. Self-Assessment Tool for “Very High Individual Risk”
of Gonorrhea or Chlamydia**

This approach to identifying women who are at “very high individual risk” of gonorrhea or chlamydia is based on the notion that the woman is often the best judge of whether she is at risk, assuming she has the accurate, up-to-date information she needs to make this determination. The following steps are intended to guide the provider in assisting a woman through this “self-assessment” process. Throughout this process, the provider should make clear that the woman does not have to share any information regarding her or her partner’s sexual behaviors.

1. Explain that having an IUCD inserted is not recommended for women who are at very high individual risk for certain STIs (gonorrhea or chlamydia). Explain why.
2. Tell her that you are going to list some possibly risky situations that—if they have occurred recently in a woman’s life—would place her at very high individual risk for these STIs (gonorrhea or chlamydia). Encourage the woman to consider these situations carefully in assessing her own risk and the possibility of having an STI. Possibly risky situations include any of the following (especially within the last 3 Months or so):
 - ◆ A sexual partner has recently had STI symptoms such as pus coming from his penis, pain or burning during urination, or an open sore in the genital area.
 - ◆ She or a sexual partner was diagnosed with an STI recently.
 - ◆ She has had more than one sexual partner recently.
 - ◆ She has a sexual partner who has had other partners recently. You can also mention any other high-risk situations that may exist locally. For example, if men in the community who work away from home for long periods of time often return with STIs, you might add, “She has a sexual partner who works away from home for long periods of time.”
3. Ask the woman whether, after considering these risky situations, she thinks the IUCD is an appropriate choice for her, or whether she would like to consider other contraceptive methods.
 - ◆ If the woman does not think the IUCD is an appropriate choice for her, or would like to consider other contraceptive methods:
 - ◆ Counsel her on contraceptive methods that may be more appropriate.
 - ◆ Urge the use of condoms, alone or with another method, to protect against STIs.
 - ◆ Provide the alternative method now, if appropriate (and a back-up method, if needed).
 - ◆ Consider the need for further evaluation/treatment (if current STI is suspected).
 - ◆ If the woman still wants to use the IUCD, but you have strong reason to believe that she is at “very high individual risk” for gonorrhea or chlamydia, advise her that IUCD insertion can be reconsidered once current gonorrhea and chlamydia have been reliably ruled out or successfully treated.

5.2. Physical Examination

After history taking, you should conduct a focused physical examination that should include:

- ◆ **General and systemic examination**
Abdominal examination
- ◆ **Pelvic examination** (this includes):
External genitalia examination
Bimanual examination
Speculum examination of the vagina and cervix

(If findings from the bimanual examination are unclear (e.g., position or size of uterus not determined, perform a **rectovaginal examination**).

NOTE: Normally, a speculum examination is completed before the bimanual examination. However, in most IUCD clients, this would mean two speculum insertions (one for the speculum examination; another after the bimanual examination for IUCD insertion), which can be unpleasant for the woman. The following guidelines have been developed especially for the IUCD client:

- ◆ If findings from the history and visual inspection are normal (infection is *not* suspected), perform the bimanual examination first and the speculum examination second; then, with the speculum still in place, proceed directly to sounding the uterus and IUCD insertion.
- ◆ If findings from the history or visual inspection are not normal (infection is suspected), perform the speculum examination first and the bimanual examination second. Proceed to sounding the uterus and IUCD insertion only if indicated.

Pre-examination Preparations

- ◆ Ensure that HLD / sterile supplies, and light source are available and ready for use.
- ◆ Using HLD/ sterile cheatles forceps, arrange the instruments and supplies in the Stainless Steel tray, being very careful not to touch any parts that will go into the vagina or uterus.
- ◆ Ensure that IUCD is available in a pre sterilized pack

- ◆ ENSURE the client’s privacy.
- ◆ Ask the woman to empty her bladder and wash perineum with clean water
- ◆ Provide additional information and reassurance, as needed.
- ◆ Before doing per vaginal examination, wash your hands thoroughly with soap and water; dry them with a clean, dry cloth or allow them to air dry or perform the alcohol rub.
- ◆ Put clean HLD gloves on both hands.
- ◆ Make her lie down on the table in the dorsal position with knees flexed and abducted to expose her perineal area.

Table 5.2 Physical Examination in clients opting for IUCD

General and systemic examination		
1. Does she have signs of anemia or heart disease? (Pallor of skin, conjunctiva, or nail beds, brittle nails or rapid pulse >100 beats/min or any abnormal heart sounds/murmurs.	NO	Proceed with the assessment.
	YES Anemia: The IUD can generally be used, but additional care/follow-up may be needed. This is because copper-bearing IUDs may increase menstrual bleeding. CVS: If uncomplicated valvular heart disease (Cat 1) IUCD can be inserted.	What to do: • If the woman has Mild to Moderate anemia (known or suspected) It falls under Cat 2- treat and insert. Prescribe iron folate, counsel on local, iron-rich foods • If available, do a hemoglobin/hematocrit test. Hb less than 7 gm/dl or Hct less than 24 indicates Severe anemia, for which IUCD should not be inserted. If has complicated valvular disease (Cat 2) MOs can insert and give prophylactic antibiotics.
Abdominal Examination Any suprapubic/ pelvic tenderness /masses/swellings	NO	Proceed with the assessment.
	YES	Refer
Pelvic examination		
A. Examination of External genitalia Are there ulcers on the vulva, vagina, or cervix? (Check for ulcers, buboes, and also palpate the Skene’s and Bartholin’s glands for tenderness and/or discharge.	NO	Proceed with the assessment.
	YES The IUCD should not be inserted. These symptoms indicate possible STI and should be treated first.	What to do: Advise the woman that IUCD insertion can be reconsidered once current STI have been successfully treated.

B. Bimanual examination.	NO	Proceed with the assessment.
	YES The IUCD should not be inserted till further evaluation for PID and ectopic pregnancy	What to do: Advise the woman that IUCD insertion can be reconsidered once current PID and ectopic have been reliably ruled out or successfully treated.
1. Does the client feel pain when you move the cervix (cervical motion tenderness)?	NO	Proceed with the assessment.
	YES The IUCD should not be inserted. This is because the provider must know the size and position of the uterus in order to safely insert and properly place the IUCD.	What to do: Refer to a specialist
2. Were you unable to determine the size and position of the uterus? (Determine size, shape and position of the uterus)	NO	Proceed with the assessment.
	YES The IUCD should not be inserted. This is because this condition may prevent proper placement of the IUCD.	What to do: Advise her that the IUCD should not be used by women in this situation. Help her choose a different method.
3. Are there uterine fibroids or an anatomical abnormality that distorts the shape of the uterine cavity?	NO	Proceed with the assessment.
	YES The IUCD should not be inserted at this time. These symptoms indicate possible PID or another problem.	What to do: Urge the use of condoms and conduct further evaluation and provide appropriate treatment according to national guidelines/local protocols (refer if needed).
4. Is there pain in the uterus, ovaries, or fallopian tubes (adnexal tenderness)?	NO:	Proceed with the assessment.
	YES The IUCD should not be inserted until infection has been ruled out or successfully treated. These symptoms indicate possible PID or STI.	What to do: Advise the woman that IUCD insertion can be reconsidered once infection has been successfully treated. Provide her with an alternative method in the interim.
C. Speculum examination	NO	Proceed with the assessment.
	YES The IUCD can generally be used in this situation, but there may be some difficulties inserting the IUCD.	Proceed with the assessment.
1. Are there cervical lacerations or narrowing of the cervical canal (stenosis)?	NO	Proceed with the assessment.
	YES The IUCD should not be inserted until infection has been ruled out or successfully treated. These symptoms indicate possible PID or STI.	What to do: Advise the woman that IUCD insertion can be reconsidered once infection has been successfully treated. Provide her with an alternative method in the interim.
2. Is there purulent cervical discharge (cervicitis)?	NO	Proceed with the assessment.
	YES The IUCD can generally be used in this situation, but there may be some difficulties inserting the IUCD.	What to do: Advise the woman that IUCD insertion can be reconsidered once infection has been successfully treated. Provide her with an alternative method in the interim.

The checklist for screening a client for IUCD is given in Annexure 7

After determining whether the woman is a good candidate for IUCD use, perform the following steps as appropriate:

- ◆ If the woman is a suitable candidate for IUCD insertion at the time, provide the IUCD now, as appropriate
- ◆ If there is a problem or reason to withhold IUCD insertion temporarily (e.g., until the next menses if pregnancy can not be ruled out) or permanently (e.g., as in the case of severe uterine anomalies), follow the steps in Textbox 5.2.

Text box 5.2 What to do if the woman is not currently eligible for IUCD use

Always:

- ◆ Provide clear information on why the IUCD is being withheld (either temporarily or permanently).
- ◆ Explain any further evaluation or treatment that is needed.
- ◆ Conduct further evaluation and provide treatment according to national guidelines/local protocols (refer, if needed), as appropriate.

If the IUCD is being temporarily withheld:

- ◆ Ensure that the woman understands exactly what needs to happen before the IUCD can be reconsidered (e.g., menstruation, in the case of suspected pregnancy; successful treatment, in the case of infection).
- ◆ Provide a back-up method* to use in the interim.
- ◆ Schedule a follow-up appointment for reassessment.

If the IUCD is being permanently withheld:

- ◆ Discuss other, more appropriate contraceptive methods.
- ◆ Help her choose one that is well suited to her needs and situation.
- ◆ Provide the alternative method now, if possible. (Provide a back-up method*, if needed.) Schedule a follow-up appointment, as appropriate.

* *Back-up methods include abstinence, male and female condoms, spermicides, and withdrawal. Spermicides and withdrawal are the least effective methods. (If possible, give the woman condoms.)*

6. Insertion and Removal

6.1. Background

IUCD insertion and removal should be performed only by providers (physicians, nurses, and midwives) who have been trained to perform these procedures. Problems associated with IUCDs (e.g., IUCD expulsion, infection, uterine perforation) are uncommon, but when they do occur, they are often due to improper insertion technique.

Although IUCD insertion and removal procedures are relatively simple, there are several, discrete steps to be performed in a specific sequence, as detailed in this chapter. These steps must be integrated with the appropriate infection prevention and counseling measures to help ensure the safety and well-being of the woman.

Key objectives of IUCD insertion and removal services are to:

- ◆ Perform IUCD insertion and removal procedures properly in a manner that is safe and as comfortable as possible for the woman
- ◆ Provide the woman with information she needs to ensure safe and effective use of the IUCD (or to discontinue the method/switch to another method, if appropriate)

6.2. Physical Requirement

Equipment and Supplies recommended for IUCD insertion

- ◆ Examination table with clean cover
- ◆ Linen/ cloth to cover the woman's pelvic area
- ◆ Cheatle's forceps
- ◆ Sponge holding forceps
- ◆ Sim's/Cusco's speculum
- ◆ Anterior vaginal wall retractor
- ◆ Volsellum/Allis forceps
- ◆ Uterine sound

- ◆ Long Sharp cutting scissors (Preferably curved 7-8” long)
- ◆ Long artery straight forceps (for IUCD removal)
- ◆ Kidney tray
- ◆ Stainless Steel (SS) tray with cover
- ◆ Gloves (high-level disinfected surgical gloves or examination gloves)
- ◆ Dry gauze or cotton swabs
- ◆ Stainless Steel Bowls -2
- ◆ Antiseptic solution (chlorhexidine or povidone iodine)
- ◆ Plastic bucket for decontamination
- ◆ Clean sanitary pads
- ◆ Autoclave/Steriliser/Boiler/Container with lid for boiling
- ◆ Light source sufficient to visualize cervix (e.g., flashlight)
- ◆ IUCD (in an unopened, undamaged, sterile package that is not beyond its expiry date and has been stored in a cool dry place.)

Figure 6.1 Basic Minimum Instruments for IUCD insertion

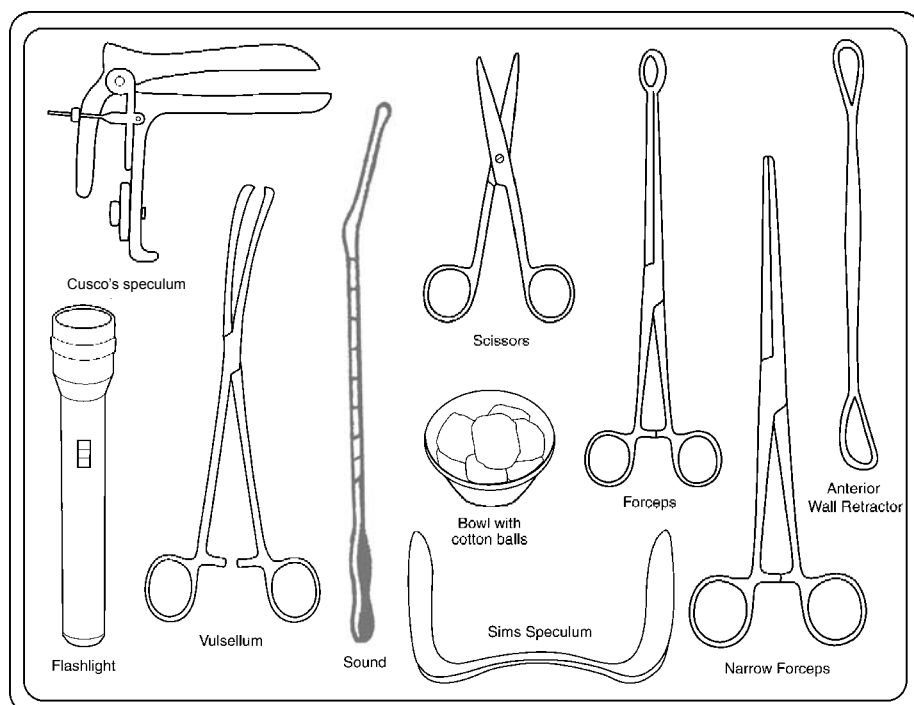

6.2.1. Timing of the Insertion

- ◆ Within seven days of the beginning of last menstrual period or anytime during the menstrual cycle provided the service provider is reasonably sure that woman is not pregnant.
- ◆ Immediately or within 48 hours after delivery (by a provider who is trained in inserting IUCDs during this time) or more than 6 weeks post partum.
- ◆ Concurrently with 1st trimester medical termination of pregnancy.
- ◆ After 1st menstrual period following spontaneous/medical/second trimester abortion
- ◆ In a woman with Lactational Amenorrhea provided pregnancy can be ruled out.
- ◆ Within 5 days of unprotected sex as an emergency contraception.

6.2.2. Place of Insertion

IUCD could be inserted at subcenter, primary health center, community health centers or hospital facility by a trained health care provider.

6.2.3. Appropriate Setting for IUCD services

An examination room in an outpatient clinic or a minor surgery room in a hospital is a suitable setting for IUCD insertion or removal. If possible, the room should be located away from heavily used areas of the facility, offer privacy, and:

- ◆ Examination or procedure table with a washable surface
- ◆ Be adequately lit and well-ventilated (with tight-fitting screens on any open windows)
- ◆ Be clean, orderly, free of dust and insects
- ◆ Have tile or concrete floors to facilitate cleaning
- ◆ Provide leak-proof containers (with tight-fitting lids) or plastic bags for disposal of contaminated waste items
- ◆ Have nearby hand washing facilities, including a supply of clean water (i.e., clear, not cloudy or with sediment)

6.2.4. Appropriate Attire for Clients and Staff

IUCD insertion and removal are minor procedures, therefore:

- ◆ Clients can wear their own clothing.
- ◆ Staff members do not have to wear a cap, mask, or gown.

6.3. Steps in IUCD Insertion

STEP 1: Prepare the client:

- ◆ Give the woman a brief overview of the procedure, encourage her to ask questions, and provide reassurance as needed.
- ◆ Remind her to let you know if she feels any pain. Ensure that IUCD is available in a pre-sterilized pack.
- ◆ Confirm that the woman has undergone appropriate counseling and assessment to ensure she is eligible for IUCD insertion at this time.
- ◆ If the woman has serious concerns about discomfort, offer her an NSAID, such as paracetamol /ibuprofen /mefenemic acid /dicyclomine 30 minutes before the procedure
- ◆ Conduct the physical examination as already explained in Chapter 5 and if the client is eligible for the use of CuT, using gentle, “no-touch” (aseptic) technique throughout, perform the subsequent steps.

STEP 2: Put a new pair of clean, high-level disinfected gloves on both hands or wash the gloved hands in antiseptic solution

STEP 3: Keeping steady, the already inserted high-level disinfected (or sterile) speculum in the vagina, proceed to the next step (Figure 6.2)

Figure 6.2 Inserting the Speculum

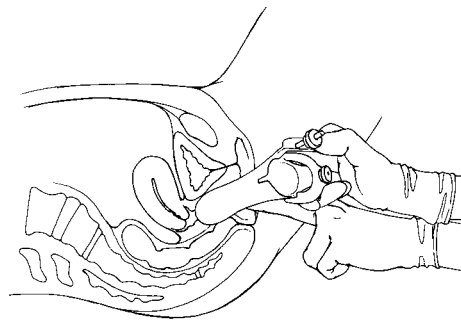

STEP 4: Cleanse the cervix and vagina with an appropriate antiseptic:

Thoroughly apply an appropriate antiseptic (e.g., povidone iodine or chlohexidine) two or more times to the cervix and vagina starting with the cervical canal. If povidone iodine is used, ensure that the woman is not allergic to iodine and wait 2 minutes for the solution to act.

STEP 5: Gently grasp the anterior lip of cervix with the high-level disinfected (sterile) volsellum and apply gentle traction: (i.e., pull gently), which will help straighten the cervical canal for easier insertion of the IUCD. Close the volsellum *only to the first notch* to minimize discomfort.

Figure 6.3 Gently Grasping the Cervix with the Volsellum

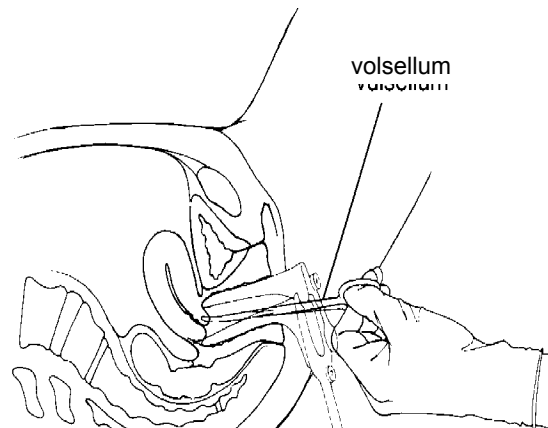
**Step 6: Sounding of Uterus****Brief overview of the procedure of Sounding the Uterus:**

- ◆ Insert a speculum to visualize the cervix.
- ◆ Clean the cervix and vagina.
- ◆ Apply a volsellum to the cervix.
- ◆ Gently pull the volsellum to align the uterus, cervical opening, and vaginal canal.
- ◆ Insert the sound into the vagina and through the cervical opening.
- ◆ Advance the sound into the uterine cavity until a slight resistance is felt.
- ◆ Remove the sound and assess the level of mucus/blood to determine the length of the uterus.

Carefully insert the high-level disinfected (or sterile) sound:

While maintaining gentle traction on the volsellum, carefully insert the tip of the sound into the cervical os. Hold the sound between the finger and the thumb, the curve of the sound facing upwards in case of anteverted uterus and backwards in case of retroverted uterus. Be careful not to touch walls of vagina or the speculum blades with the tip of the sound.

Fig. 6.4 Sounding an anteverted uterus

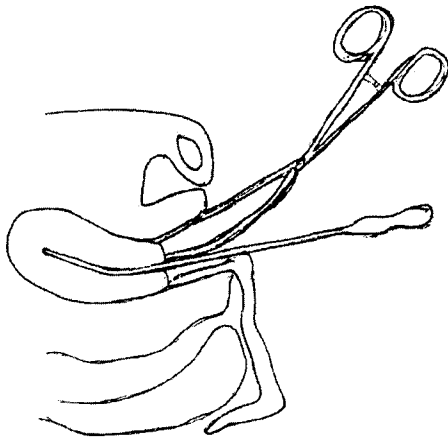
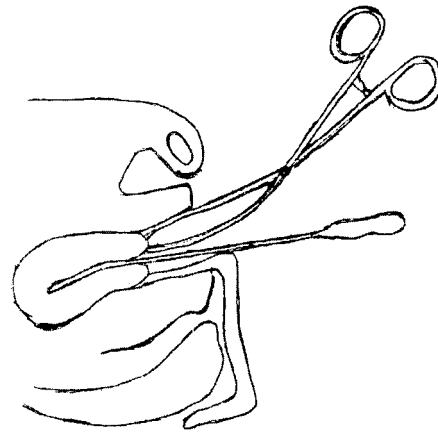

Fig. 6.5 Sounding a retroverted uterus



STEP 7: Gently advance the sound into the uterine cavity, and STOP when a slight resistance is felt:

- ◆ Advance the sound carefully and gently into the uterine cavity at the appropriate angle (based on your assessment of the position of the uterus during bimanual examination).
- ◆ Continue to pull steadily downward and outward on the volsellum, which should enable the sound to pass through the os more easily.
- ◆ If any resistance is felt at the level of the internal os, use a smaller sound, if available. Do not attempt to dilate cervix
- ◆ If the woman begins to show signs of fainting, STOP advancing the sound into the uterine cavity.

Do not use force at any stage of this procedure.

- ◆ When you feel a slight resistance, STOP advancing the sound into the uterine cavity. (A slight resistance indicates that the tip of the sound has reached the fundus.)
- ◆ If a sudden loss of resistance is felt, the uterine length is greater than expected, or the woman is experiencing unexplained pain, STOP advancing the sound into the uterine cavity. For guidance on managing possible uterine perforation, *Please refer chapter 8.*

STEP 8: Note the angle of the uterine cavity (for IUCD insertion), and gently remove the sound.

Do not pass the sound into the uterus more than once.

STEP 9: Determine the length of the uterus:

- ◆ Determine the length of the uterus by noting the level of mucus or wetness on the sound. (The average uterus is between 6 and 8 cm in length. If the uterus is less than 6.5 cm in length, the woman may be at increased risk for IUCD expulsion.)
- ◆ Place the sound in 0.5% chlorine solution for 10 minutes for decontamination.

STEP 10: Loading the IUCD in its sterile package

Brief overview of the procedure:

- ◆ Partially open the package.
- ◆ Place the plunger rod in the insertion tube.
- ◆ Place the “arms” of the “T” inside the insertion tube.
- ◆ Set the length-gauge.
- ◆ Align the length-gauge and folded arms of the T to horizontal position.
- ◆ Remove the IUCD from the package.

Rationale: This simple but critical step prevents the IUCD from being contaminated before it is inserted, further reducing the risk of post insertion infection. *Refer to Annexure 8 for detailed steps for loading regular Cu T 380A.*

STEP 11: Keep communicating with the client to keep her comfortable

STEP 12: Apply gentle traction on the cervix with the volsellum: Hold the loaded IUCD with one hand so that the blue length-gauge is in the horizontal position, while grasping the volsellum (still in place after sounding the uterus) with the other hand and gently pull outward and downward. (This will help straighten the cervical canal for easier insertion of the IUCD.)

STEP 13: Insert the loaded IUCD: Carefully insert the loaded IUCD into the vaginal canal (Figure 6.6), and gently push it through the cervical os and into the uterine cavity at the appropriate angle (based on your assessment of the position of the uterus when sounding the uterus). Be careful not to touch the walls of the vagina or the speculum blades with the tip of the loaded IUCD.

Figure 6.6 Inserting the Loaded IUCD

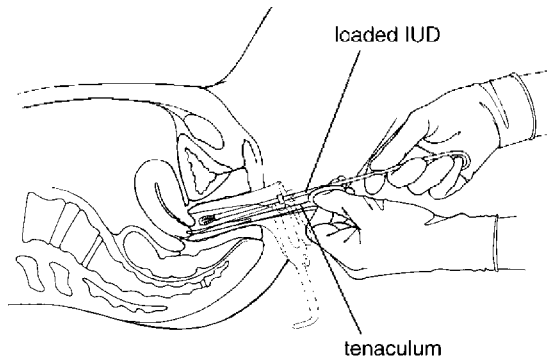
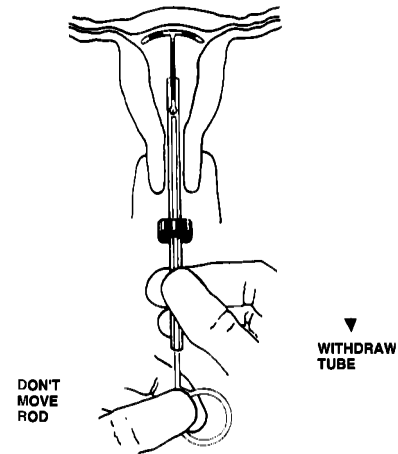

Figure 6.7 Withdrawing the insertion tube to release IUCD arms



STEP14: Gently advance the loaded IUCD into the uterine cavity, and **STOP** when the blue length-gauge comes in contact with the cervix or slight resistance is felt. Be sure that the blue length-gauge is still in the horizontal position.

Do not use force at any stage of this procedure.

STEP 15: Hold the volsellum and white plunger rod stationary, while partially withdrawing the insertion tube: While holding the volsellum and plunger rod stationary (in one hand), gently pull the insertion tube toward yourself (with your free hand) until it touches the circular thumb grip of the white plunger rod (Figure 6.7). This will release the IUCD in the woman's uterus.

STEP 16: Remove the white plunger rod, while holding the insertion tube stationary. The plunger should be removed before the insertion tube is pulled out, otherwise the threads may be caught between the tube and the plunger, resulting in downward displacement or expulsion of the IUCD from the uterus.

STEP17: Gently push insertion tube until you feel a slight resistance: Once the plunger rod has been removed, very gently and carefully push the insertion tube upward again, toward the fundus of the uterus, until you feel a slight resistance (Figure 6.8a). This step ensures that the arms of the T are as high as possible in the uterus, as shown in Figure 6.8b.

Do not pass the loaded IUCD into the uterus more than once.

STEP 18: Use high-level disinfected (sterile) sharp scissors to cut the IUCD strings at 3 to 4cm of length:

- ◆ Partially withdraw the insertion tube from the cervical canal until the strings can be seen extending from the cervical os, and use sharp scissors to cut the strings at 3 to 4 cm from

the cervical opening. This technique ensures that the pieces of cut-off string will stay in the insertion tube for easy disposal.

- ◆ Place the insertion tube and scissors in 0.5% chlorine solution for 10 minutes for decontamination.

Note: Sharp blades are very important. If the scissor blades are too blunt to cut well, the IUCD strings may become trapped in the closed blades of the scissors, and the IUCD may be accidentally removed when the scissors are withdrawn.

Figure 6.8a Positioning IUCD high in the uterus

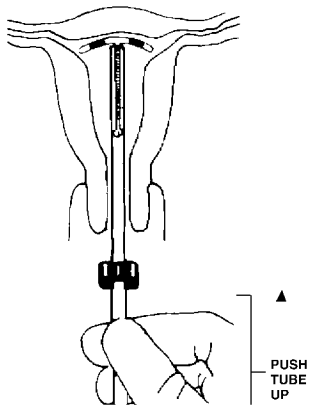
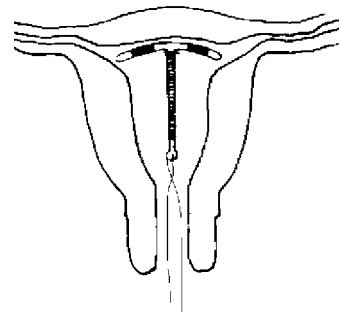

Figure 6.8b IUCD fully inserted in uterus



STEP 19: Gently remove the volsellum with open ends and place it in 0.5% chlorine solution for 10 minutes for decontamination.

STEP 20: Examine the woman's cervix for bleeding:

If there is bleeding in the cervix where the volsellum was attached, use high-level disinfected (or sterile) forceps or place a cotton (or gauze) swab on the affected tissue, and apply gentle pressure for 30 to 60 seconds. Also ensure to remove the cotton once the bleeding stops.

STEP 21: Gently remove the speculum and place it in 0.5% chlorine solution for 10 minutes for decontamination.

STEP 22: Allow the woman to rest. Advise the woman to remain on the examination table until she feels ready to get up. Begin performing the post-insertion steps (below) while she is resting.

Post insertion Processing

- ◆ Before removing your gloves:

Place all used instruments in 0.5% chlorine solution for 10 minutes for decontamination if not already done.

Dispose off waste materials (e.g., cotton balls) by placing them in a leak-proof container (with tight-fitting lid) or plastic bag.

- ◆ Immerse both gloved hands in 0.5% chlorine solution. Remove gloves by turning them inside out.

If disposing off the gloves, place them in the leak-proof container or plastic bag.

If reusing the gloves (not recommended), submerge them in 0.5% chlorine solution for 10 minutes for decontamination.

- ◆ Wash hands thoroughly with soap and water; dry them with a clean, dry cloth or allow them to air dry.

After the client has left, change the linen with every client. if feasible.

Ensure that all instruments, gloves, and other reusable items are further-processed according to recommended infection prevention practices (Table 7-1, page 54).

6.3.1. Post insertion Assessment

- ◆ Ask the woman how she is feeling, and whether she is experiencing any of the following symptoms:

Nausea, mild-to-moderate lower abdominal pain/cramping, dizziness or fainting (rare)

- ◆ If the woman is experiencing any of these symptoms, provide reassurance and allow her to remain on the examination table to rest until she feels better.

6.3.2. Post insertion Education/Counseling

- ◆ Before the woman leaves the clinic, provide her key messages (as specified in Annexure 8) for women who have just had an IUCD inserted.
- ◆ Make the client repeat the key information to ensure that she understands and has retained it.
- ◆ Encourage her to ask questions and state any remaining concerns.
- ◆ Provide reassurance, as needed.
- ◆ Complete the clinic records and card for the IUCD user (*Annexure 11*).

Figure 6.9 Flowchart summarizing general steps involved in IUCD insertion

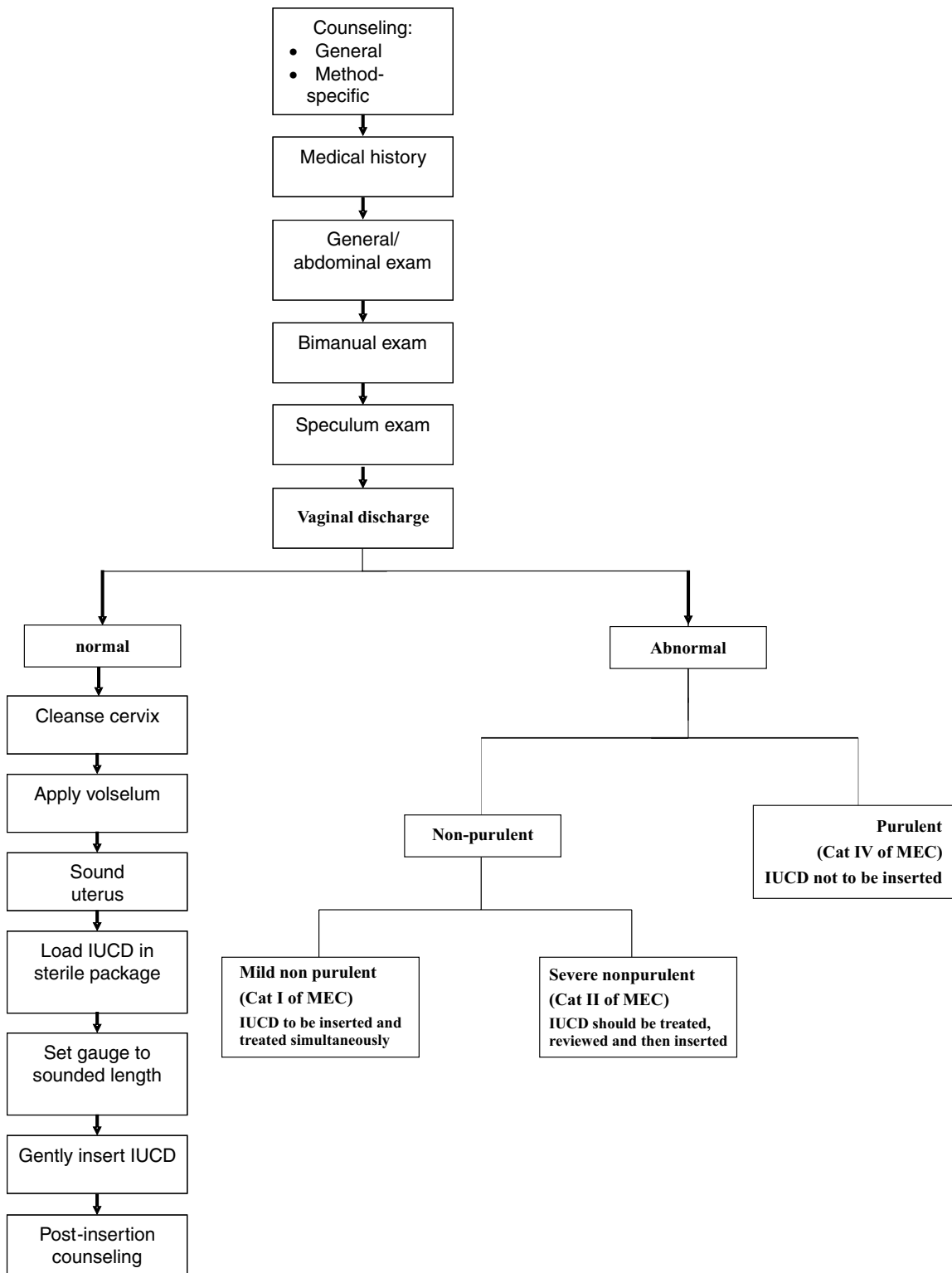

6.4. IUCD Removal

IUCD removal is usually an uncomplicated and relatively painless routine procedure. Unless an IUCD is removed for a medical reason or because the woman wishes to discontinue the method, a new IUCD can be inserted immediately after removing the old one, if she so desires. Appropriate assessment and care, before and after the procedure, depend on the reason for IUCD removal, and whether the woman is having another IUCD inserted or is starting a different method. Note also that pre-procedure preparations and post-procedure processing steps are essentially the same as for IUCD insertion, and are not repeated here.

6.4.1. Before Removing the IUCD

Indications for IUCD removal

Personal reasons (offers no reason at all) The woman has a right to discontinue the method at any time, regardless of the reason.

Wants another child provide information on antenatal care, care during pregnancy, labor and delivery.

IUCD to be replaced (i.e., at the end of its effective life of 10 years or before if she desires) ensure that she has undergone appropriate assessment to determine whether she is eligible for IUCD reinsertion at this time.

Medical reasons (e.g., pregnancy, heavy menstrual bleeding) ensure that she has undergone the appropriate assessment to determine whether routine IUCD removal is safe for her at this time. Refer if needed.

Starting a different method ask when her LMP began. This will help her choose an appropriate back-up method. (*refer Text Box 6.2*)

Menopause

Evidence of IUCD displacement

Ensure that she understands the following key points about having her IUCD removed, as appropriate:

“She can get pregnant again immediately after IUCD removal.”

“If she does not want to become pregnant, she should immediately have another IUCD inserted or start another contraceptive method.”

“No rest period is needed between IUCDs.”

6.4.2. Equipments and supplies

- ◆ All the equipments and supplies as used for insertion
- ◆ Straight artery forceps

6.4.3. Steps for IUCD Removal

Using gentle, “no-touch” (aseptic) technique throughout, perform the following steps to remove IUCD:

STEP 1: Prepare the client:

- ◆ Give the woman a brief overview of the procedure, encourage her to ask questions, and provide reassurance as needed.
- ◆ Remind her to let you know if she feels any pain.

STEP 2: Put clean/ high-level disinfected gloves on both hands.

STEP 3: Insert a high-level disinfected (or sterile) speculum and visualize the cervix and the IUCD strings.

- ◆ If the strings cannot be seen, manage as Missing Strings.

STEP 4: Cleanse the cervix and vagina with an appropriate antiseptic:

Thoroughly apply an appropriate antiseptic (e.g., povidone iodine or chlohexidine) two or more times to the cervix (wiping from inside the os outward) and vagina. If povidone iodine is used, ensure that the woman is not allergic to iodine and wait 2 minutes for the solution to act.

STEP 5: Alert the woman before you remove the IUCD:

- ◆ Ask her to take slow, deep breaths and relax.
- ◆ Inform her that she may feel some discomfort and cramping, which is normal.

Do not use force at any stage of this procedure.

STEP 6: Grasp the IUCD strings and apply gentle traction:

- ◆ Grasp the strings of the IUCD with a high-level disinfected (or sterile) straight artery forceps (Figure 6.10).
- ◆ Apply steady but gentle traction, gently pulling the strings toward you with the forceps (Figure 6.10, Right panel). (The device can usually be removed without difficulty.)

If the strings break off but the IUCD is visible, grasp the device with the forceps and remove it.

If removal is difficult, do not use excessive force. See the textbox (6.10) written below for guidance on managing this problem.

Figure 6.10 Removing the IUCD

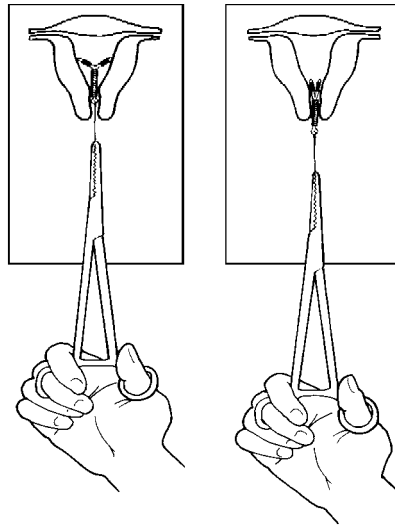

Text Box 6.1 Guidelines for Difficult IUCD Removals

If you have partially removed the IUCD but have difficulty drawing it through the cervical canal:

- ◆ Attempt a gentle, slow twisting of the IUCD while gently pulling.
- ◆ Continue as long as the woman remains comfortable.

If the IUCD can still not be removed, refer the woman to a specially trained provider who can dilate the cervix.

If there seems to be a sharp angle between the uterus and cervix:

- ◆ Place a high-level disinfected (or sterile) volsellum on the cervix, and apply gentle traction downward and outward.
- ◆ Attempt a gentle, slow twisting of the IUCD while gently pulling.
- ◆ Continue as long as the woman remains comfortable.

If the IUCD can still not be removed, refer the woman to a specially trained provider.

STEP 7: Show the woman the IUCD, and place it in 0.5% chlorine solution for 10 minutes for decontamination.

STEP 8: Insert a new IUCD, if the woman so desires and there are no precautions to continued use. If she is not having a new IUCD inserted, gently remove the speculum and place it in 0.5% chlorine solution for 10 minutes for decontamination.

6.4.4. Post Removal counselling

- ◆ Ask the woman how she is feeling, and whether she is experiencing any of the following symptoms:

Nausea, Mild-to-Moderate lower abdominal pain/cramping, Dizziness or fainting (rare)

If the woman is experiencing any of these symptoms, provide reassurance and allow her to remain on the examination table to rest until she feels better.

Important: Although most women will not experience problems after IUCD removal, all women should remain at the clinic for 15 to 30 minutes as a precaution.

- ◆ If the woman is starting a new contraceptive method, it should be provided now—along with a back-up method if needed (Textbox 6.2).

Textbox 6-2 Guidelines for Switching to Another Contraceptive Method and Need for Back-Up Methods*

- ◆ If the woman is switching to combined oral contraceptives (COCs), and:
- ◆ The IUCD is being removed within 5 days since her LMP started, no back-up method is needed.

The IUCD is being removed at any other time, and: She has been sexually active in this menstrual cycle, delay IUCD removal until her next period. She has not been sexually active in this menstrual cycle, provide a back-up method* for her to use for the first 7 days after starting the COCs.

- ◆ If the woman is switching to any other method, and:

The IUCD is being removed within 7 days since her LMP started, no back-up method is needed. The IUCD can be removed at this time.

If it is more than 7 days since her since her LMP started, and: She has been sexually active in this menstrual cycle, delay IUCD removal until her next period. She has not been sexually active in this menstrual cycle, provide a back-up method* for her to use for the first 7 days after starting the new method.

* Back-up methods include abstinence, male and female condoms, spermicides, and withdrawal. Spermicides and withdrawal are the least effective methods, and spermicides are no longer recommended as they have been found to alter the vaginal wall and make the vaginal wall more susceptible to infection. If possible, give the woman condoms. Note that the IUCD can be left in place as the back-up method and removed during the next period.

7. Infection Prevention

7.1. Background

The consistent use of recommended infection prevention practices is another critical component of quality health services, as well as a basic right of every patient, client, or staff member in a health care setting. Although there is only a minimal risk of infection associated with IUCD use, studies have shown that it is often related to the insertion procedure (ARHP 2004), rather than to the IUCD itself. When the procedure is performed correctly, however, and in accordance with the recommended infection prevention practices, the rate of infection following IUCD insertion is very low—less than 1%.

Key objectives of infection prevention in providing IUCD services are to:

- ◆ Reduce the risk of infection due to IUCD insertion
- ◆ Reduce the risk of disease transmission to IUCD clients and potential IUCD clients
- ◆ Protect health care workers at all levels—from physicians and nurses to housekeeping staff—from getting infection.

It is mandatory to practice appropriate infection prevention procedures at all times with all clients to decrease the risk of transmission of infection including Human immunodeficiency virus (HIV), Hepatitis C (HCV), and Hepatitis B (HBV).

Standard Universal Precautions of infection prevention include:

1. *Hand Washing*
2. *Self protection such as wearing gloves and physical barrier*
3. *Safe Work Practices (Prevent injuries from sharps)*
4. *Maintain correct environmental cleanliness*
5. *Correct processing of instruments and other items*
6. *Proper waste disposal practices and handling, transporting and processing used/soiled linens correctly*

7.2. Standard Precautions

Standard Precautions are designed for the safety and care of all people in a health care facility—whether a hospitalized patient, a woman receiving IUCD services, or a health care worker.

- ♦ **Washing hands:** Routine hand washing should be done before wearing gloves, after examination or after having any direct contact with a client, and after removing the gloves. Plain or antiseptic soap should be used for routine hand washing. Hands should be rinsed in a stream of running water and dried with a clean personal towel or air-dried. Towel should not be shared. *Practices such as using a common basin where a number of people or even one person washes or dips his/her hands repeatedly is dangerous and must be abandoned.* (Refer Text box 7.1 for details)
- ♦ **Use of gloves:** In the context of IUCD services, gloves are worn during the pelvic examination of a potential IUCD user, before and after inserting or removing an IUCD.
- ♦ **Use antiseptic agents:** Before IUCD insertion/removal apply a water-based antiseptic to the cervix and vagina two or more times
- ♦ **Safely dispose off infectious waste materials** to protect those who handle them or spread of infection to the community.

Text Box 7.1 Steps in Hand washing

Lather soap

Rub the palms, dorsum, nails of both hands; scrub the thumbs and fingers, webs and then the wrists.

Continue to do so for 10-15 seconds.

Then wash hands upto the wrists in running water.

If running water is unavailable use a big vessel with a tap or arrange for someone to pour water with a tumbler.

Alternatively alcohol hand rubs could be used in high volume clinics and clinics where access to water is limited. Alcohol hand rub can be prepared by adding 2 ml of glycerin to 100 ml of 60-70% alcohol. Three ml of alcohol hand rub should be applied to the hands and hands should be rubbed till alcohol dries up. Alcohol hand rub should be used before and after every client contact, and before and after removing gloves. Hands should be washed with clean water and soap once the hands feel sticky due to residual glycerine.

7.3. Processing of Equipment, Instruments and Other Reusable Items:

This includes 5 steps which are described as follows

Step 1: Decontamination

- ◆ Immediately after use, fully immerse all instruments in a plastic container filled with 0.5% chlorine solution for 10 minutes. (This step helps prevent transmission of HBV and HIV to staff. It should be done before staff is allowed to handle or clean instruments.)

Note: If the instruments will not be cleaned (STEP 2) immediately after decontamination, rinse them with water and dry them with a clean towel to minimize possible corrosion of the instruments due to chlorine.

- ◆ Wipe all large surfaces (e.g., procedure table, instrument stand) that could have been contaminated by blood or other body fluids with a 0.5% chlorine solution.
- ◆ While still wearing gloves (dispose off waste [STEP 4], if appropriate), briefly immerse both gloved hands in the bucket containing the 0.5% chlorine solution and then carefully remove them by turning them inside out.
- ◆ If disposing off gloves, place them in a leak-proof container (with tight-fitting lid) or plastic bag.
- ◆ If reusing surgical gloves, submerge them in the chlorine solution and soak them for 10 minutes.

Preparation of 0.5% Chlorine solution using 30% bleaching powder.

Mix 15 gm of commercially available bleaching powder in one liter of tap water. Stir well and filter the water to remove rest of the powder before using the solution. The solution needs to be changed once in 24 hours or whenever it becomes milky white in color.

Annexure 10B gives the pictorial details of Chlorine solution preparation

Step 2: Cleaning and Rinsing

After decontaminating instruments:

- a. Thoroughly scrub them under the surface of the water with a soft brush (e.g., a toothbrush) and liquid soap or detergent. Pay special attention to teeth, joints, and screws, where organic material may collect.
- b. After cleaning, rinse items well to remove all soap or detergent. (This step is important because some detergents can leave a residue that interferes with the action of chemical disinfectants used for HLD [or sterilization].)

- c. After rinsing, air dry or dry items with a clean towel.
- d. Once items are dried, proceed with HLD (or sterilization). Wash **large surfaces** (e.g., procedure table, instrument stand) with soap and water if organic material remains on them after decontamination.

STEP 3: HLD (Recommended for IUCD Services)

After decontaminating instruments and surgical gloves and cleaning and rinsing instruments, High-level disinfect them using one of the following processes:

Boil items for 20 minutes and dry:

- a. Open or take apart items.
- b. Fully immerse items in water in a covered pan and heat.
- c. Bring water to a rolling/bubbling boil, and boil for 20 minutes in a pot with a lid.
- d. Do not add anything to the pot after boiling begins.
- e. Remove items using high-level disinfected forceps, and place in a high-level disinfected container.
- f. Allow items to cool and air dry.
- g. Use objects immediately or store them in a covered airtight, dry high level disinfected container for up to 7 days. If stored in an ordinary covered container, it can be used up to 24 hours.

Alternatively, soak items in special chemicals for 20 minutes, rinse, and dry:

- a. Fully immerse items in an appropriate high-level disinfectant (i.e., 2% glutaraldehyde or 0.1% chlorine solution), prepared as described in Annexure 10A.
- b. Soak them for 20 minutes.
- c. Remove items using new/clean examination or high-level disinfected surgical gloves, and high-level disinfected forceps.
- d. Rinse items three times with boiled and filtered (if necessary) water.
- e. Place them in a high-level disinfected container and air dry.

Alternate Step 3: Sterilization (Not essential for IUCD services if HLD is available)

Sterilization by steam: After decontaminating and cleaning and rinsing instruments, sterilize them by autoclave (121°C [250°F] and 106 kPa [15 lb/in²] for 20 minutes if unwrapped and 30 minutes if wrapped; or by dry-heat (170°C [340°F] for 60 minutes).

Note: Dry-heat sterilization can be used only for metal or glass instruments, not gloves.

Sterilized packs can be used up to one week if kept dry and intact and drum is not opened. Once drum is opened, use only for 24 hours.

Sterilization by chemical method

- ◆ Decontaminated, cleaned and dried items are put in 2 per cent glutaraldehyde solution for at least 8 to 10 hours.
- ◆ Items such as scissors and forceps should be put into the solution in an open position.
- ◆ Do not add or remove any items once timing starts
- ◆ Items should be rinsed well with sterile water (not boiled water), air-dried and stored in a covered sterile container for up to seven days. Sterile water can be prepared by autoclaving water for 20 minutes at 15 lb/sq inches in an autoclave.

(Annexure 10A contains detailed instructions on making chlorine solutions for decontamination and HLD.)

Step 4: Waste Disposal

- ◆ After completing a procedure (e.g., IUCD insertion or removal), and while still wearing gloves, dispose off **contaminated waste** (e.g., gauze, cotton, disposable gloves) in a properly marked leak-proof waste container (with a tight-fitting lid) or plastic bag.
- ◆ The waste should be disposed off properly. It is better to be buried or burnt. Burning should preferably be done in an incinerator or steel drum as opposed to open burning.
- ◆ If burning is not possible, waste should be put in a pit and buried but never be thrown outside or left in open pits.
- ◆ For waste that is to be picked up by the municipalities, these should be contained in closed dumpsters prior to removal.

Step 5: Storage

Use high-level disinfected instruments and gloves immediately, or store them for up to 1 week in a high-level disinfected container with a tight-fitting cover. (Sterilized instruments not used immediately should be stored in a dry, sterile container with a tight-fitting cover.)

Important: Although alcohols and iodophors are inexpensive and readily available disinfectants, they are no longer classified as high-level disinfectants (Rutala 1993). Alcohols do not kill some viruses, and *Pseudomonas* species have been known to multiply in iodophors. These chemicals should be used for disinfection only when high-level disinfectants are not available or appropriate.

Figure 7.1 Flow Chart summarizing processing Surgical Instruments, Gloves, and Other Items*

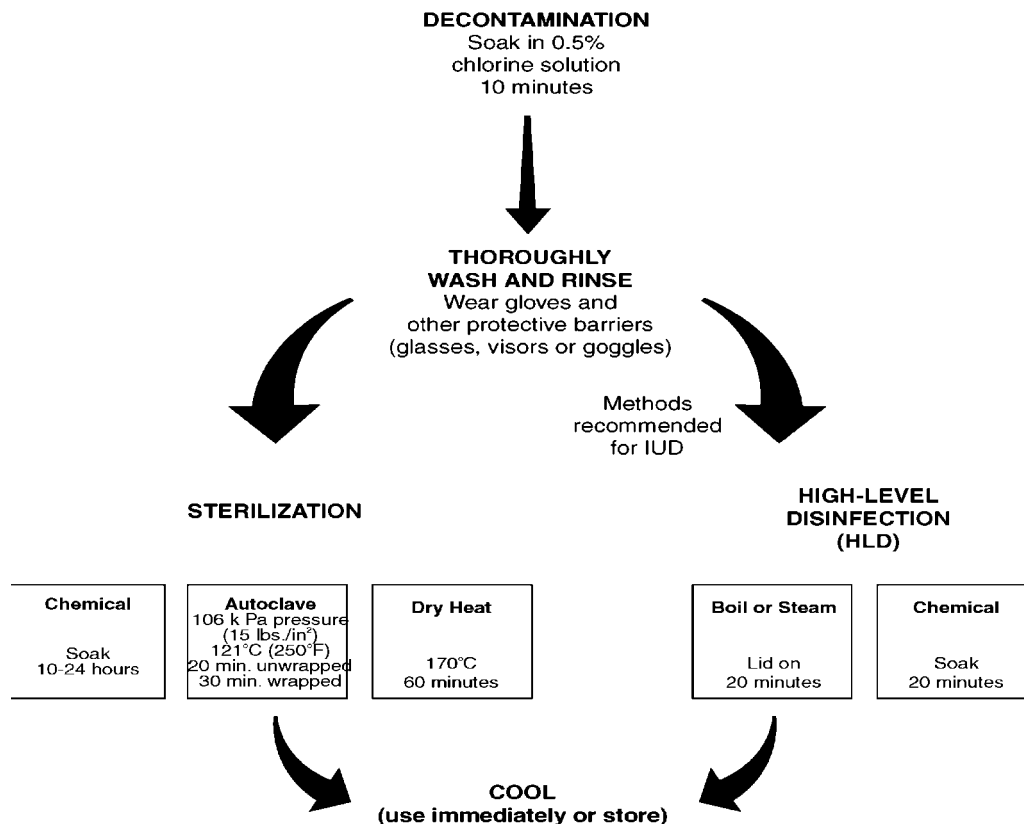

Please refer to Annexure 10 C for summarization of the above steps

7.4. Specific Infection Prevention Tips for IUCD Insertion or Removal

7.4.1. Before IUCD Insertion or Removal (as Applicable)

- ◆ Ensure that instruments and supplies are available and ready for use.
- ◆ Ensure that the IUCD package is unopened and undamaged. The IUCD package should not be opened until the final decision to insert the IUCD has been made.
- ◆ Do not shave her genital area.
- ◆ Place a dry, clean cloth between her genital area and the surface of the examination table.
- ◆ Wash hands thoroughly with soap and water; dry them with a clean, dry cloth or allow them to air dry.
- ◆ Put new/clean examination gloves or high-level disinfected (or sterile) surgical gloves on both hands.

* Adapted from: WHO 1990.

7.4.2. During IUCD Insertion or Removal (as Applicable)

- ◆ Before sounding the uterus and inserting the IUCD (after performing the speculum examination, with the speculum still in place), thoroughly apply a water-based antiseptic (2.5% povidone iodine or chlorhexidine) two or more times to the cervix and vagina before beginning the procedure. Cleanse from the inside of the cervical os outward.

If povidone iodine is used, allow 1 to 2 minutes before proceeding.

Iodophors such as povidone iodine require contact time to act.

Do not use alcohol. Alcohol is painful for the woman, and also dries and damages the mucous membranes, which may support the infectious process.

- ◆ Load the IUCD in its sterile package.
- ◆ Throughout the procedure, use the “no-touch” technique to reduce the risk of contaminating the uterine cavity. Using the “no-touch” technique during IUCD insertion means that the uterine sound and the loaded IUCD:
 - Are not allowed to touch the vaginal walls or the blades of the speculum (or any other nonsterile surface that may contaminate them); and
 - Are not passed through the cervical os more than once.

7.4.3. After IUCD Insertion or Removal

- ◆ Before removing your gloves:

Place all used instruments (they should be in the open state) in 0.5% chlorine solution for 10 minutes for decontamination, if not already done.

Dispose off waste materials (e.g., cotton balls) by placing them in a leakproof container (with tight-fitting lid) or plastic bag.

Immerse both gloved hands in 0.5% chlorine solution. Remove gloves by turning them inside out.

- ◆ If disposing of the gloves, place them in the leak-proof container or plastic bag.
- ◆ If reusing the gloves (not recommended), submerge them in 0.5% chlorine solution for 10 minutes for decontamination.

- ◆ Wash your hands thoroughly with soap and water; dry them with a clean, dry cloth or allow them to air dry.
- ◆ After the client has left, wipe the examination table with 0.5% chlorine solution to decontaminate.

8. Follow-up care and Management of Potential Problems

8.1. Background

The long-term success of a family planning program can be achieved only when service providers and other staff recognize the importance of providing strong support services to their clients. High-quality follow-up care for family planning clients contributes to greater user satisfaction, as well as to safe and effective continued use of the method.

Routine follow-up for many IUCD users may involve little more than answering questions and reinforcing key messages. Some users, such as those who are bothered by side effects, may require additional care and support. Serious problems related to IUCD use are uncommon, but when they do occur, prompt and appropriate management is essential.

Key objectives of follow-up care for IUCD clients are to:

- ◆ Assess the woman's overall satisfaction with the IUCD
- ◆ Identify and manage potential problems
- ◆ Address any questions or concerns the woman may have
- ◆ Reinforce key messages

8.2. Follow-up Visits

The recommended follow up schedule is first visit after the first menstrual period or after one month whichever is earlier. Subsequent visits after 3 months and thereafter once a year. Unscheduled visits as and when required.

(Please see Annexure 11 for IUCD follow up card)

8.2.1. Follow Up Care

The basic components of routine follow-up care are essentially the same for new and continuing users. Some components, however, may be more important for new users, such as:

- ◆ Assessing for menstrual changes (most common side effect of IUCD use), which often subside within a few months of IUCD insertion;
- ◆ Assessing for infection, which is uncommon but most likely to occur in the first 20 days after IUCD insertion; and
- ◆ Checking for IUCD expulsion, which is very uncommon but most likely to occur within the first few months after IUCD insertion.

For a continuing user, on the other hand, it may be more critical to assess for significant changes since her last visit, such as in her overall health, reproductive goals, or individual risk for HIV and other STIs.

Although the following guidelines are appropriate for all return visits, specific points that may be emphasized for new or continuing users are indicated as such.

8.2.2. Routine Follow-Up Assessment

History

- ◆ Assess the woman's overall satisfaction with the method, and check for problems:
- ◆ Assess for common side effects (e.g., an increase in the amount or duration of menstrual bleeding, increase in pain/cramping with period, or spotting/light bleeding between periods).

Screen for warning signs (PAINS): (*Please refer to Annexure 9*)

Ask whether she has checked for IUCD expulsion.

Ask whether she has been using condoms for protection against STIs, as needed.

Physical Examination

- ◆ For the first routine checkup, perform a pelvic examination to ensure that the IUCD is still in place and check for signs of infection.
- ◆ For all other return visits, perform a pelvic examination as indicated (e.g., if infection is suspected).

8.3. Management of Problems

Most side effects associated with the use of IUCDs are not serious and will resolve spontaneously. Some problems, however, require specific management. The purpose of the guidelines below is to assist the clinician in providing appropriate support for a woman experiencing such side effects or problems. In most cases, the woman can continue to use the IUCD while awaiting or undergoing evaluation.

Some of the problems associated with IUCD use that require specific management include:

- ◆ Menstrual irregularities
- ◆ Cramping or pain
- ◆ Infection
- ◆ IUCD string problems (missing strings or possible IUCD expulsion)
- ◆ Partial or complete expulsion IUCD (confirmed)
- ◆ Pregnancy with an IUCD in place
- ◆ Uterine perforation

8.3.1. Menstrual Irregularities

Change in menstrual bleeding pattern is a common side effect among users of copper-bearing IUCDs*. These changes are usually not harmful to the woman and diminish or disappear within the first few months after IUCD insertion. If, however, these symptoms are severe, persistent, or accompanied by certain other signs/symptoms, they require special follow-up.

Possible Signs/Symptoms:

- ◆ Increase in amount of menstrual bleeding
- ◆ Increase in duration of menstrual bleeding
- ◆ Spotting/light bleeding between periods

* May be more relevant for new IUCD users

Management:

Manage as appropriate based on findings:

- ◆ If her menstrual bleeding lasts twice as long or is twice as heavy as usual, conduct further evaluation and provide treatment according to local protocols/national guidelines (refer if needed).
- ◆ If her menstrual bleeding changes have continued beyond 3 to 6 months after IUCD insertion and a gynecologic problem is suspected, conduct further evaluation and provide treatment (refer if needed).

8.3.2. Cramps or pain during menstruation

Increased cramping or pain associated with menstruation is another common side effect among users of copper-bearing IUCDs. Special follow-up is needed, however, if these symptoms are bothersome, severe, or associated with other signs/symptoms that suggest they are not related to menstruation, conduct appropriate assessment (including pelvic examination) to identify or rule out other possible causes of the symptoms, such as infection, partial IUCD expulsion, uterine perforation, and pregnancy/ectopic pregnancy. When other possible causes of the symptoms are ruled out, manage as appropriate based on findings. If cramping or pain, provide reassurance and recommend ibuprofen (200–400 mg every 4–6 hours) or another NSAID immediately before and during menstruation to help reduce symptoms. If it still persists, remove the IUCD.

8.3.3. Infection

According to the latest research, the risk of infection after IUCD insertion, while very low, is highest within the first 20 days after insertion. It is important to note that a pelvic infection does not necessarily develop into PID (PID refers to any infection that ascends into the woman's uterus and fallopian tubes), and that it is caused due to infection with Gonorrhea or Chlamydia, not due to IUCD. However, because PID can lead to infertility and other serious problems, and because diagnosis of PID can be difficult, providers should treat all suspected cases. The following guidelines are intended to assist the provider in identifying pelvic infection, including suspected cases of PID, and treating accordingly.

Possible Signs/Symptoms:

- ◆ Lower abdominal pain
- ◆ Painful intercourse
- ◆ Postcoital, intermenstrual or contact bleeding

- ◆ Pain associated with periods (especially if this symptom was absent during the first few months after IUCD insertion but developed later)
- ◆ Abnormal vaginal discharge
- ◆ Painful urination (dysuria)
- ◆ Fever
- ◆ Nausea and vomiting

Management:

- ◆ Conduct appropriate assessment (including abdominal and pelvic examinations) to identify or rule out other possible causes of the symptoms, such as ectopic pregnancy and appendicitis.
- ◆ Advise the woman that she should begin treatment immediately to avoid serious potential consequences of the infection, and that the IUCD does not need to be removed during treatment (unless symptoms do not improve within 72 hours).
- ◆ However, if the woman insists on IUCD removal, arrange to have the IUCD removed under antibiotic coverage for 2 to 3 days.
- ◆ Treat the woman for gonorrhoea, chlamydia, and anaerobic infections (*Please refer to annexure 6*)

8.3.4. String Problems (Possible IUCD Expulsion)

Missing, shorter, or longer strings may indicate a variety of problems, including IUCD expulsion or malposition and uterine perforation, or may not indicate a problem at all. Sometimes, for example, the IUCD strings may ascend into the uterus for no known reason. Strings that are too short may bother the woman's partner during sexual intercourse. Guidance for following up on all these potential problems is provided below.

For missing strings:

Rule out pregnancy.

Once pregnancy has been ruled out: Probe the cervical canal using a high-level disinfected (or sterile) long artery forceps to locate the strings, and gently draw them out so that they are protruding into the vaginal canal. Manage as appropriate based on findings:

- ◆ If the strings are located and drawn out, and the woman wants to keep the IUCD, leave it in place (provided it seems properly placed).

- ◆ If the strings are located and drawn out, and the woman does not want to keep the IUCD, remove the IUCD
- ◆ If the strings are not located in the cervical canal (or cannot be drawn out), and the woman does not want to keep the IUCD, refer her for IUCD removal by a specially trained provider. (A specially trained provider can use a sound to check whether the IUCD is in place, being very careful not to injure the uterus. If the IUCD is still in place, the strings can be drawn out using a long artery forceps.)
- ◆ If indicated, refer the woman for an ultrasound (X ray, if ultrasound is unavailable) to help determine whether the IUCD is still in place, is malpositioned, or has been expelled.

8.3.5. Expulsion of IUCD (Partial or Complete)

Partial or complete IUCD expulsion can occur unnoticed or may be associated with other signs/symptoms, such as irregular bleeding, pain with intercourse (for either woman or partner), unusual vaginal discharge, and/or bleeding after sex. Missing or longer IUCD strings and delayed or missed menstrual period are other possible indications. The following guidelines address management of confirmed partial or complete IUCD expulsions.

Possible Signs/Symptoms:

- ◆ Expelled IUCD seen (complete expulsion)
- ◆ IUCD felt/seen in the vaginal canal (partial expulsion)

Management:

- ◆ Conduct appropriate assessment (including pelvic examination) to rule out other possible causes of the symptoms, such as infection and pregnancy.
- ◆ If complete expulsion of the IUCD is confirmed (e.g., seen by the woman and confirmed by ultrasound or X-ray):

Replace IUCD now if desired and appropriate (no signs of infection, pregnancy ruled out);
or

Provide alternative method if possible, as well as a back-up method if needed.

- ◆ If partial IUCD expulsion is confirmed by health care provider:

Remove the IUCD

Replace IUCD now if desired and appropriate (no signs of infection, pregnancy ruled out);
or

Provide alternative method if possible, as well as a back-up method if needed.

- ◆ If the IUCD seems to be embedded in the cervical canal, refer the woman for IUCD removal to a specialist

8.3.6. Pregnancy with an IUCD in place

While the IUCD is one of the most effective forms of reversible contraception, failures can occur. Approximately one-third of IUCD-related pregnancies are due to undetected partial or complete expulsion of the IUCD.

Possible Signs/Symptoms:

- ◆ Delayed or missed menstrual period
- ◆ Other signs/symptoms of pregnancy

Management:

1. Confirm pregnancy.
2. Rule out ectopic pregnancy.
3. When ectopic pregnancy has been ruled out, determine whether the woman wants to continue her pregnancy.
4. If the woman does not wish to continue her pregnancy and she is in permissible period of termination (i.e. upto 20 weeks), document her decision and obtain formal consent for Medical Termination of pregnancy (MTP). Remove the IUCD immediately if strings are seen, even if her MTP is scheduled for later. Refer if needed.
5. If she wishes to continue the pregnancy, advise the woman that the IUCD may be removed if strings are visible. Inform the woman on the risks involved of IUCD with pregnancy:
6. Leaving the IUCD in place can cause second-trimester miscarriage, infection, and preterm delivery. Removing the IUCD slightly increases the risk of miscarriage
7. In case IUCD is not removed, closely monitor the pregnancy and look for expelled IUCD at the time of abortion/ delivery.

8.3.7. Uterine Perforation

Uterine perforations occur very rarely, with most occurring resulting from poor insertion technique. It could be detected during the insertion procedure or much later after the procedure. Risk is higher in case of post abortion or immediate post partum clients and in clients where the uterine size measures less than 6 cm.

Possible Signs/Symptoms of a suspected uterine perforation:

During insertion procedure

- ◆ Sudden loss of resistance to the uterine sound or IUCD insertion device during IUCD insertion
- ◆ Uterine length greater than expected from uterine sound

Detected after insertion procedure:

- ◆ Unexplained abdominal pain
- ◆ Missing threads
- ◆ Confirmed by UCG/X-ray

Management:

1. Suspected perforation during Insertion:

Stop the procedure immediately, and gently remove the instrument/object that may have perforated the uterus (e.g., sound, assembly unit)

- ◆ In case of perforation during sounding, stop the procedure and gently remove the sound and observe.
- ◆ If perforation has occurred with the assembly unit and the IUCD has not been released, stop the procedure and remove the assembly unit and abandon the procedure.
- ◆ If perforation has occurred with the assembly unit and IUCD has been released and the threads are visible then try to remove the IUCD by applying gentle traction. If you feel any resistance, then abandon the procedure and refer to a specialist. Have the woman rest and monitor her vital signs (blood pressure, pulse, respiration, and temperature) and level of discomfort until stable. For the first hour, check her vital signs every 15 minutes.

If her vital signs are not stable (e.g., elevated pulse, falling blood pressure), or there is bleeding or new/increased pain, refer/transport the woman for emergency care.

If her vital signs remain stable after 1 hour, check for signs of intra-abdominal bleeding (e.g., test hematocrit/hemoglobin). If there are signs of intra-abdominal bleeding, refer/transport the woman for emergency care.

When the woman's vital signs have been stable for 24 hours, she can go home. Advise her to avoid having sex for 2 weeks, provide a back-up method, and arrange for appropriate follow-up.

2. Perforation detected late (missing strings/ persistent pain/ pregnancy)

Refer the woman to a specialist or higher facility for management

9. Improving the Quality of IUCD Services

9.1. Background

Quality of care refers to the way in which individuals and couples are treated by the health care system providing services. The objective of this chapter is to provide clinicians and clinic managers with basic information and tools on **how to improve and maintain performance and quality of health services**.

Improving the quality of IUCD services includes improving providers' performance, creating a supportive work environment, meeting clients' needs with their input and recognizing progress that providers make.

Successful IUCD services programs are characterized by:

- ◆ realistic goal setting;
- ◆ emphasis on quality and client satisfaction;
- ◆ provision of services in a manner acceptable to the client;
- ◆ effective and efficient management and monitoring systems;
- ◆ efficient logistics and
- ◆ a good referral system.

The quality and performance improvement process involves four steps:

- ◆ setting standards of performance in an operational way;
- ◆ implementing standards through a streamlined and systematic methodology;
- ◆ measuring progress to guide the improvement process toward these standards and
- ◆ recognizing the achievement of the standards.

9.2. Standards For Quality IUCD Services

This section focuses on standards or principles that can guide program managers to effectively implement the IUCD services. There are eight key areas to monitor the performance of the IUCD services. These areas include:

1. Human and Physical Resources
2. Client focused IEC materials for Family Planning
3. Management systems
4. Infection prevention
5. FP new client: General counseling
6. Providing IUCD to a new client
7. Follow up visit and management of IUCD side effects and problems
8. IUCD removal

As a guideline framework some of the performance standards in each key area have been mentioned below. The program managers can adapt these guidelines for monitoring the implementation of services.

S.No	Key Areas	Performance standards
1	Human and Physical Resources	<p>The provider is trained to provide IUCD and other FP services</p> <p>The clinic has adequate clean space for providing the services.</p> <p>The clinic has an area where counseling can be done in privacy.</p> <p>The clinic has instruments and equipment to provide IUCD services.</p> <p>The clinic has sufficient supplies of IUCDs.</p> <p>The clinic has Infection Prevention supplies and record keeping and reporting materials to provide family planning services.</p> <p>Good storage principles are applied to contraceptives, essential drugs and medical supplies.</p>
2	Client focused IEC materials for Family Planning	<p>The clinic has informational posters or panels on the family planning services offered and clinic timing.</p> <p>There is information on client's rights regarding family planning.</p> <p>The clinic has flip charts/ IEC material and samples of family planning methods for counseling.</p>
3	Management Systems	<p>There are written routine protocols/ instructions for the delivery of Family planning services.</p> <p>The clinic has a simple FP client record system.</p> <p>The records are reviewed and analysed regularly.</p>

S.No	Key Areas	Performance standards
4	Infection Prevention practices	<p>There is clean running water available in the clinic.</p> <p>Facility for hand hygiene is readily available.</p> <p>The availability and use of antiseptics for skin and/or mucous membranes are as per the standards.</p> <p>The decontamination of instruments and other articles (immediately after use and before cleaning) is performed according to the standards.</p> <p>The waste disposal system is according to standards.</p>
5	Family Planning Services/ New Client –General Counselling	<p>The provider uses adequate interpersonal communication skills during the entire visit.</p> <p>The provider gives information about the contraceptive methods available in the clinic and confirms the woman's choice.</p> <p>The provider rules out pregnancy.</p>
6	Providing IUCD to a New Client	<p>The provider assesses the woman's eligibility to use the IUCD.</p> <p>The provider explains about the warning signs with the IUCD.</p> <p>The provider performs the pre insertion tasks and inserts the IUCD as per guidelines</p> <p>The provider gives instructions about the return and/or follow up visits.</p>
7	Follow up Visit and Management of IUCD side effects and problems	<p>The provider verifies the woman's satisfaction with the IUCD.</p> <p>The provider identifies the side effects or problems with the IUCD.</p> <p>The provider manages side effects and problems with IUCD.</p> <p>The provider gives instructions about the return and/ or follow up visits for the IUCD.</p>
8	IUCD Removal	<p>The provider prepares for the procedure.</p> <p>The provider removes the IUCD following the standard procedure guidelines.</p> <p>The provider performs the post removal tasks and counseling on other family planning methods.</p>

This section has outlined eight key areas and some standards under each key area, which will guide effective delivery of IUCD services.



Annexures

Annexure 1

Different types of IUCD

First Generation IUCDs: Lippes Loop

Inert device made of polyethylene or other polymers, appeared in different shapes and sizes-loops, spirals, coils, rings and bows.

Types: according to size could be A, B, C and D, D being the largest. Larger the size, greater the antifertility effect and a lower expulsion rate but a lower continuation rate due to side-effects like pain and bleeding.

Second Generation IUCDs

Earlier devices: Cu-7

Cu T-200

Newer devices: (Variants of T device)

T Cu-200 B

T Cu-380A (currently provided under the National Family Welfare Program)

Nova T: (Multiload devices)

ML-Cu-250

ML-Cu-375

Third Generation IUCDs

(These are hormonal – available on a limited scale)

Progestasert : T shaped device filled with 38mg of Progesterone, releasing 65mcg daily

LNG 20 (Mirena) T shaped IUCD releasing 20mcg of Levonorgestrel –More potent

Annexure 2

Guidelines for use of IUCDs as Emergency Contraception

Emergency contraception refers to back-up methods for contraceptive emergencies which women can use within the first few days after unprotected intercourse to prevent an unwanted pregnancy.

Indications for emergency contraception:

- ◆ After voluntary sexual act without contraceptive protection.
- ◆ Incorrect or inconsistent use of regular contraceptive methods:
 - failure to take oral contraceptives for more than 3 days
 - being late for contraceptive injection
- ◆ In case of contraceptive failure or mishaps: miscalculation of infertile period, expulsion of an Intrauterine device and failed coitus interruptus, or in case of slippage /leakage of condom
- ◆ In the event of sexual assault.

Methods of emergency contraception:

- ◆ All hormonal oral contraceptive pills (combined as well as single) like:
 - high doses of progestogen only pill containing levonorgestrel and
 - high doses of combined oral contraceptive containing ethylestradiol and levonorgestrol (Yuzpe regimen)
- ◆ *Copper releasing Intrauterine devices (IUCD) such as CuT 380A*

A copper releasing IUCD can be used as a very effective method of preventing pregnancy if used **within five days** of the first episode of unprotected sexual intercourse.

Mechanism of action

The mechanism of action is the same as for contraception and it primarily acts by preventing fertilization and implantation

Advantages of IUCDs as an Emergency contraception

- ◆ The woman who has accepted the IUCDs as an emergency contraception has the option to continue to use the same IUCDs as a regular contraceptive thereby contributing to the reproductive health of the woman.
- ◆ The time limit for the effective post coital use of the method for preventing pregnancy is longer ie. five days or 120 hours for IUCDs and only 72 hours in the case of EC pills.
- ◆ It is effective even in situations of multiple episodes of unprotected sexual intercourse.

Counseling

Counseling on emergency contraception is no different from counseling on other Family Planning methods. As it is a relatively new back-up method, and most clients do not know much about it, it is important that potential clients are properly informed. The steps for counseling are same as in Chapter 3. A special attention should be paid to the following issues/areas:

- ◆ A proper counseling will help to provide emotional support to the client/couple who is worried about a pregnancy due to unprotected sexual intercourse.
- ◆ It establishes rapport and confidence in the provider as the provider is helping them in a critical need.
- ◆ It provides an opportunity to help the client start using a regular contraceptive method of their choice with full information as well as ensure sustained correct use of the same.
- ◆ Making the client feel psychologically comfortable in the case of sexual assault and to be nonjudgmental in such cases

Once the client is sure to use the IUCD follow the steps in method specific counseling

Eligibility criteria

They are the same as when IUCD is used for regular contraception but special care should be taken in the case of sexual assault cases as presence of STIs increases the risk of PID. It is also important to find out the first act of unprotected sexual intercourse while eliciting the history. The IUCD can then be used for continuing contraception, or removed at the next menses.

Client assessment: Get accurate information of the timing of first unprotected intercourse

In the case of contraceptive accident find out how the method was used. Provide information on all methods of EC available in the country and the comparative advantages of each

Insertion of IUCD

Timing of insertion is critical (within 5 days of first act of unprotected sexual intercourse). The steps of insertion and infection prevention practices are the same as in Chapters 6. Follow up care of all women after the first menstrual period is critical to make sure that the client is not pregnant and that IUCD is in situ.

Management of complications/side effects same as in chapter and the follow up visits to be ensured when the client decides to continue the same method as a regular contraception.

Annexure 3

Myths and misconceptions regarding IUCD

The following are some of the more common rumors/myths about the IUCD:

Rumor/myth: The IUCD might travel through the woman's body, maybe to her heart or her brain.
Response: Explain that the IUCD usually stays in the uterus until it is removed. If it does come out by itself, it comes out through the vagina. In the rare event that the IUCD perforates the uterus (travels through the wall of the uterus) it will remain in the abdomen. An IUCD is too big to travel to the heart or to the brain. (Show her a picture or Model of the uterus with the IUCD in it.)

Rumor/myth: IUCDs prevent pregnancy by causing abortion.
Response: Explain that recent studies show that copper IUCDs works by preventing sperm from fertilizing a woman's egg, rather than by destroying a fertilized egg.

Rumor: The IUCD will interfere with sex.
Response: Explain that because the IUCD is located in the uterus, not the vaginal canal, neither the woman nor her partner will feel it during sex. It is possible that the partner will feel the strings, but this can be easily corrected if it becomes a problem.

Rumor/myth: The IUCD may rust inside the woman's body.
Response: Explain to the woman that the IUCD will not rust inside her body, even after many years.

Many misconceptions about the IUCD remain despite scientific evidence to the contrary. These are:

Misconception: IUCD increases a woman's risk of ectopic pregnancy.

Response: The IUCD reduces the risk of ectopic pregnancy by preventing pregnancy. Because IUCDs are so effective at preventing pregnancy, they also offer excellent protection against ectopic pregnancy. Women who use copper-bearing IUCDs are 91% less likely than women using no contraception to have an ectopic pregnancy (Sivin 1991).

Misconception: IUCD causes PID, and it needs to be removed to treat PID.

Response: Strict randomized controlled trials and literature reviews reveal that PID among IUCD users is rare (ARHP2004; Grimes 2000). Early studies that reported a link between PID and IUCD use were flawed and poorly designed. Inappropriate groups were used for comparison, infection in IUCD users was over-diagnosed, and there was a lack of control for confounding factors (Buchan et

al. 1990; Vessey et al. 1981). Women who have a history of PID can generally use the IUCD (the advantages generally outweigh the risks), provided their current risk for STIs is low.

Misconception: IUCD causes infertility.

Response: Infertility caused by tubal damage is associated not with IUCD use, but with chlamydia (current infection or—as indicated by the presence of antibodies—past infection) (Hubacher et al. 2001). Moreover, there is an immediate return to fertility after an IUCD has been removed (Belhadj et al. 1986). In one study, 100% of women who desired pregnancy (97 of 97) conceived within 39 Months of IUCD removal (Skjeldestad and Bratt 1988).

Misconception: IUCD is unsuitable for use in nulliparous women.

Response: Nulliparous women can generally use the IUCD (the advantages generally outweigh the risks). However, expulsion rates tend to be slightly higher in nulliparous women compared to parous women (Grimes 2004).

Misconception: IUCD cannot be safely used by HIV-infected women who are clinically well.
Response: HIV-infected women who are clinically well can generally use the IUCD (the advantages generally outweigh the risks). A large study in Nairobi showed that HIV-infected women had no significant increase in the risk of complications, including infection in early Months, than HIV-negative women (Sinei et al. 2001). In another study of HIV-infected and HIV-negative IUCD users with a low risk of STI, no differences were found in overall or infection-related complications between the two groups (Sinei et al. 1998).

Misconception: The IUCD interferes with ARV therapy.
Response: Women who have AIDS, are on ARV therapy, and are clinically well can generally use the IUCD (advantages generally outweigh the risks). Because it is a non-hormonal family planning method, the IUCD is not affected by liver enzymes and will not interfere with or be affected by ARV therapy (ARHP 2004; Hatcher et al. 2004).

Annexure 4

Table 4.1 WHO MEC for IUCD use

Category	Description	With Clinical Judgment ^a	With Limited Clinical Judgment ^b
1	A condition for which there is no restriction for the use of the contraceptive method.	Use method in any circumstances.	Yes (Use the method.)
2	A condition for which the advantages of using the method generally outweigh the theoretical or proven risks.	Generally use the method.	
3	A condition for which the theoretical or proven risks usually outweigh the advantages of using the method.	Use of method not usually recommended unless other more appropriate methods are not available or acceptable.	No (Do not use the method.)
4	A condition that represents an unacceptable health risk if the contraceptive method is used.	Method not to be used.	

^a In care situations where resources for clinical judgment are in place (e.g., availability of skilled care, access to a wide range of services), the four-category framework corresponds to four possible determinations of whether a woman can use an IUCD.

^b In care situations where resources for clinical judgment are limited (e.g., community-based services), the four-category framework is simplified into two possible determinations of whether a woman can use an IUCD.

Sometimes a given condition is considered one category for *initiating* use (i.e., insertion) and another for *continuing* use. For example, a woman with PID should not have an IUCD inserted (Category 4), but can continue to use an IUCD already in place while receiving appropriate treatment (Category 2), if she so desires.

Any risk posed by a method should be weighed against the risk posed by unintended pregnancy on a case-by-case basis.

WHO's four-category system is intended to be used in the context of clinical judgment. This means that the provider has the knowledge, skills, and resources necessary to determine whether the benefits of using an IUCD outweigh the risks for a particular woman. This capacity is especially important when there may be some question about whether the IUCD is an appropriate choice for a particular woman. For example, a provider may—after considering all the factors involved—determine that one woman who is anemic is a good candidate for IUCD use, but advise another woman with anemia (e.g., if it is severe) to consider other, more appropriate methods. In making this determination, the provider may consider and weigh factors such as:

- ◆ Risks posed by the method versus those posed by an unintended pregnancy
- ◆ Severity of the woman's condition, and whether she is undergoing adequate treatment
- ◆ Presence of other conditions
- ◆ The woman's understanding of any special risks involved
- ◆ Access to additional services and follow-up care, as needed
- ◆ Availability/acceptability of other contraceptive methods
- ◆ Any other circumstances or factors that may be relevant

In situations in which the provider does not have the knowledge, skills, or resources necessary to make such determinations, the four categories can be simplified into two, as shown in the far right column of Table 4.2. In the context of this simplified system, women with Category 1 and 2 conditions can use the IUCD, and women with Category 3 and 4 conditions can not. Or, the provider may refer a woman to a higher level facility if there is some question about whether she can use the IUCD.

Table 4.2 WHO's four-category system

Category 1: Use the Method	Category 2: Generally use the method.	Category 3: Use of method not usually recommended unless other more appropriate methods are not available or acceptable.	Category 4: Method not to be used.
<ul style="list-style-type: none"> ◆ Women with a history of ectopic pregnancy. ◆ Women who are immediately following a first-trimester abortion (spontaneous or induced). ◆ Women who are 4 weeks or more postpartum, provided there is no evidence of infection. ◆ Women who have benign ovarian tumors (or cysts) or uterine fibroids that do not distort the uterine cavity. ◆ Women with a genital infection that is not sexually transmitted, such as vaginitis (e.g., bacterial vaginosis, candida albicans). ◆ Women who have a history of PID with a subsequent pregnancy (assuming there are no known current risk factors for STIs). ◆ Women who have breast disease, including breast cancer. ◆ Women who have viral hepatitis or malaria. ◆ Women who have diabetes, hypertension, or "uncomplicated" valvular heart disease. ◆ Women who smoke or are obese. 	<ul style="list-style-type: none"> ◆ Women who are less than 20 years of age (and nulliparous) or are nulliparous, as there is a slightly greater risk of expulsion due to the smaller size of the uterus. ◆ Women with heavy/prolonged or painful menstruation, endometriosis, or severe dysmenorrhea. ◆ Women who are immediately following a second-trimester abortion (spontaneous or induced), provided there is no evidence of infection. However, the IUCD should be inserted only by a specially trained provider (because of the increased risk of expulsion). ◆ Women who are less than 48 hours postpartum, provided there is no evidence of infection. However, the IUCD should be inserted only by a specially trained provider (because of the increased risk of expulsion). ◆ Women who have anatomical abnormalities of the reproductive tract that do not distort the uterine cavity in a way that might interfere with IUCD insertion or placement (e.g., cervical stenosis). ◆ Women who have STIs other than gonorrhea or chlamydia (e.g., herpes, syphilis). ◆ Women who are at risk for STIs other than gonorrhea or chlamydia (e.g., HIV, herpes, syphilis, hepatitis). ◆ Women who have a history of PID without a subsequent pregnancy (assuming there are no known current risk factors for STIs). ◆ Women who are HIV-infected and are clinically well. ◆ Women who have AIDS, are on ARV therapy, and are clinically well. ◆ Women who have complicated valvular heart disease (e.g., artificial shunts, rheumatic heart disease), although prophylactic antibiotics are advised for IUCD insertion to prevent endocarditis. ◆ Women with anemia (including thalassemia, sickle cell disease, and iron-deficiency anemia), although there is some concern about increased menstrual blood loss with copper-bearing IUCDs. 	<ul style="list-style-type: none"> ◆ Women who are 48 hours to less than 4 weeks postpartum. ◆ Women with benign trophoblastic disease. ◆ Women who have ovarian cancer should not have an IUCD inserted (although they are Category 2 for continuation). ◆ Women who have a high individual risk for gonorrhea or chlamydia should not have an IUCD inserted (although they are Category 2 for continuation). ◆ Women who have AIDS but are not on ARV therapy should not have an IUCD inserted (although they are Category 2 for continuation). 	<ul style="list-style-type: none"> ◆ Women who are pregnant. ◆ Women who have infection or signs/symptoms of infection within 6 weeks postpartum (puerperal sepsis), or immediately following an abortion (immediate post-septic abortion). ◆ Women with malignant trophoblastic disease. ◆ Women with cervical or endometrial/uterine cancer should not have an IUCD inserted (although they are Category 2 for continuation while awaiting evaluation). ◆ Women who have anatomical abnormalities of the reproductive tract or uterine fibroids that distort the uterine cavity in a way that might interfere with IUCD insertion or placement. ◆ Women who have pelvic tuberculosis. ◆ Women with unexplained vaginal bleeding should not have an IUCD inserted (although they are Category 2 for continuation while awaiting evaluation). ◆ Women who have current PID, purulent cervicitis, chlamydia, or gonorrhea should not have an IUCD inserted (although they are Category 2 for continuation while awaiting evaluation or undergoing treatment.)

Annexure 5

Ruling out Pregnancy

How can the provider be reasonably sure that a woman is not pregnant?

Diagnosis of pregnancy is important. The ability to make this diagnosis early in pregnancy will vary depending on resources and settings. Highly reliable biochemical urine pregnancy tests are often useful, but not available in many areas. The test becomes positive within one week of missed period (in women who have regular periods) i.e when the concentration of HCG hormone in the urine reaches 100 units and above. Specificity of the test is as high as 95%. Pelvic examination (and bimanual examination too), where feasible, is reliable at approximately 8-10 weeks since the first day of the last menstrual period.

The provider can be reasonably sure that the woman is not pregnant if she has no symptoms or signs of pregnancy and meets any of the following criteria:

- ◆ Has not had intercourse since last normal menses
- ◆ Has been correctly and consistently using a reliable method of contraception.
- ◆ Is within the first 7 days after normal menses.
- ◆ Is within 4 weeks post partum for non-lactating women
- ◆ Is within the first 7 days post abortion or miscarriage
- ◆ Is fully or nearly fully breast feeding, amenorrhoeic and less than 6 months post partum.

Annexure 6

RTI/STIs: Causative organisms, presenting symptoms and management

In India female clients suspected of having RTI/STIs usually present with the following symptoms (one/more):

- ◆ Vaginal discharge
- ◆ Vesicular and/ or non vesicular genital ulcers
- ◆ Lower abdominal pain

In the following table depicts presenting symptoms, signs and clinical conditions in RTI/STI

STI/RTI (causative organism)	Signs and symptoms
Gonorrhoea (Neisseria Gonorrhoea)	Purulent/mucopurulent vaginal discharge -Pain or burning on passing urine -Inflamed(red and tender) urethra
Trichomoniasis (Trichomonas vaginalis)	May produce few symptoms -Women have frothy(bubbly), foul smelling , greenish vaginal discharge Pruritus in 75% of cases Dysparunia and dysuria in 20% of cases
Chlamydia (Chlamydia trachomatis)	Silent PID with few symptoms and upper genital tract infection Purulent cervical discharge, frequently a beefy red cervix which bleeds easily
Bacterial vaginosis (anaerobes-eg. Gardnerella vaginalis)	Not necessarily sexually transmitted Vaginal discharge with fishy odor and grayish in color
Candidiasis (Candida albicans)	Curd-like Vaginal discharge, whitish in color Moderate to intense vaginal or vulval itching
Herpes (Herpes genitalis)	Vesicles, presenting with pain History of recurrences
Syphilis (Treponema Pallidum)	Primary Syphilis:-Initial painless ulcer(chancre): in women on the external genital genitalia(labia)

Reference: National Guidelines on Prevention, Management and Control of Reproductive Tract Infections including Sexually Transmitted Infections by NACO and MH division, GOI, Nov'06

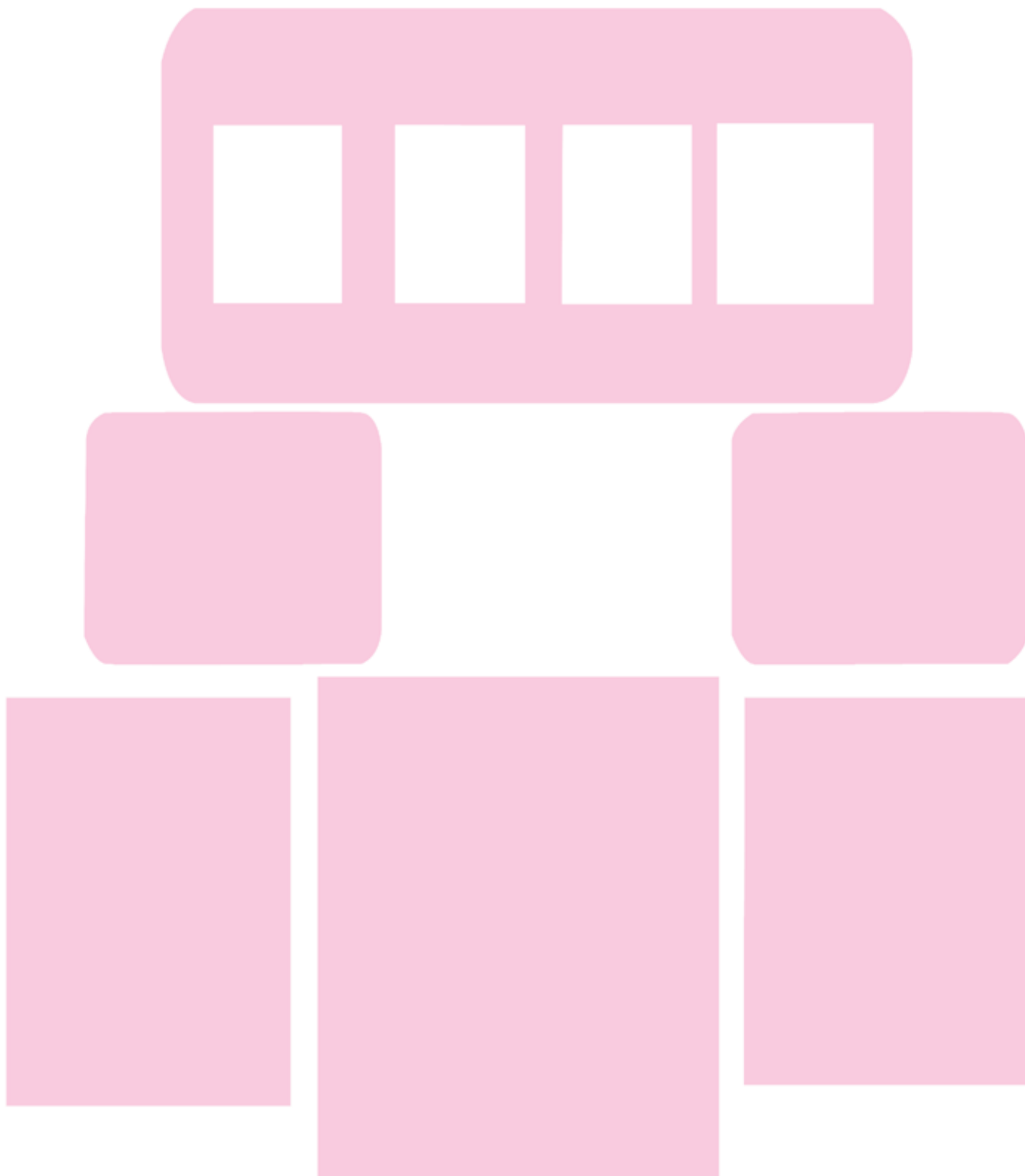



Treatment

Vaginitis (TV+BV+Candida)

- Tab Secnidazole 2gm orally, single dose or
Tab Tinidazole 500mg orally, twice daily for 5 days
- Tab. Metoclopramide taken 30 minutes before Tab. Secnidazole, to prevent gastric intolerance
- Treat for candidiasis with Tab Fluconazole 150mg orally single dose or local Clotrimazole 500mg vaginal pessaries once

Treatment for cervical infection (chlamydia and gonorrhoea)

- Tab cefixim 400 mg orally, single dose
- Plus Azithromycin 1 gram, 1 hour before lunch. If vomiting within 1 hour, give anti-emetic and repeat
 - If vaginitis and cervicitis are present treat for both
 - Instruct client to avoid douching
 - Pregnancy, diabetes, HIV may also be influencing factors and should be considered in recurrent infections
 - Follow-up after one week

Management in pregnant women

Per speculum examination should be done to rule out pregnancy complications like abortion, premature rupture of membranes

Treatment for vaginitis (TV+BV+Candida)

In first trimester of pregnancy

- Local treatment with Clotrimazole vaginal pessary/cream only for candidiasis. Oral Fluconazole is contraindicated in pregnancy.
- Metronidazole pessaries or cream intravaginally if trichomoniasis or BV is suspected.

In second and third trimester oral metronidazole can be given

- Tab. Secnidazole 2gm orally, single dose or
Tab. Tinidazole 500mg orally, twice daily for 5 days
- Tab. Metoclopramide taken 30 minutes before Tab. Metronidazole, to prevent gastric intolerance

Specific guidelines for partner management

- Treat current partner only if no improvement after initial treatment
- If partner is symptomatic, treat client and partner using above protocols
- Advise sexual abstinence during the course of treatment
- Provide condoms, educate about correct and consistent use
- Schedule return visit after 7 days

Annexure 7

Checklist for Screening Clients Who Want to Initiate Use of the Copper IUD

First, be reasonably sure that the client is not pregnant. If she is not menstruating at the time of her visit, ask the client questions 1–6. As soon as the client answers **YES** to *any question*, stop, and follow instructions below.

YES	1. Have you had a baby in the last 4 weeks?	NO
YES	2. Did you have a baby less than 6 months ago, are you fully or nearly-fully breastfeeding, and have you had no menstrual period since then?	NO
YES	3. Have you abstained from sexual intercourse since your last menstrual period or delivery?	NO
YES	4. Did your last menstrual period start within the past 12 days?	NO
YES	5. Have you had a miscarriage or abortion in the last 7 days?	NO
YES	6. Have you been using a reliable contraceptive method consistently and correctly?	NO

If the client answered **YES** to *any one of questions 1–6* and she is free of signs or symptoms of pregnancy, you can be reasonably sure that she is not pregnant. Proceed to questions 7–13. However, if she answers **YES** to *question 1*, the insertion should be delayed until 4 weeks after delivery. Ask her to come back at that time.

If the client answered **NO** to *all of questions 1–6*, pregnancy cannot be ruled out. The client should await menses or use a pregnancy test.

To determine if the client is medically eligible to use an IUD, ask questions 7–13. As soon as the client answers **YES** to *any question*, stop, and follow instructions below.

NO	7. Do you have bleeding between menstrual periods that is unusual for you, or bleeding after intercourse (sex)?	YES
NO	8. Have you been told that you have any type of cancer in your genital organs, trophoblastic disease, or pelvic tuberculosis?	YES
NO	9. Within the last 3 months, have you had more than one sexual partner?	YES
NO	10. Within the last 3 months, do you think your partner has had another sexual partner?	YES
NO	11. Within the last 3 months, have you been told you have an STI?	YES
NO	12. Within the last 3 months, has your partner been told that he has an STI or do you know if he has had any symptoms – for example, penile discharge?	YES
NO	13. Are you HIV-positive and have you developed AIDS?	YES

If the client answered **NO** to *all of questions 7–13*, proceed with the **PELVIC EXAM**.

During the pelvic exam, the provider should determine the answers to questions 14–20.

If the client answered **YES** to *question 7 or 8*, an IUD cannot be inserted. Further evaluation of the condition is required.

If the client answered **YES** to *any of questions 9–12*, she is not a good candidate for an IUD unless chlamydia and/or gonorrhea infection can be reliably ruled out.

If she answered **YES** to the *second part of question 13* and is not currently taking ARV drugs, IUD insertion is not usually recommended. If she is doing clinically well on ARVs, the IUD may generally be inserted. HIV-positive women without AIDS also generally can initiate IUD use.

NO	14. Is there any type of ulcer on the vulva, vagina, or cervix?	YES
NO	15. Does the client feel pain in her lower abdomen when you move the cervix?	YES
NO	16. Is there adnexa tenderness?	YES
NO	17. Is there purulent cervical discharge?	YES
NO	18. Does the cervix bleed easily when touched?	YES
NO	19. Is there an anatomical abnormality of the uterine cavity that will not allow appropriate IUD insertion?	YES
NO	20. Were you unable to determine the size and/or position of the uterus?	YES

If the answer to *all of questions 14–20* is **NO**, you may insert the IUD.

If the answer to *any of questions 14–20* is **YES**, the IUD cannot be inserted without further evaluation. See explanations for more instructions.

Annexure 8

Instruction for loading the IUCD

Do not open the IUCD's sterile package or load it (as instructed below) until the final decision to insert an IUCD has been made (i.e., until after the pelvic examination, including both bimanual and speculum exams, has been performed). In addition, do not bend the "arms" of the "T" into the insertion tube more than 5 minutes before the IUCD is to be introduced into the uterus.

While performing the following steps, do not allow any part of the IUCD or the IUCD insertion assembly to touch any non-sterile surfaces (e.g., your hands, the table) that may contaminate it:

STEP 1: Adjust the contents of the package Figure C-1. Vertical Stem of T Fully inside Insertion through the clear plastic cover: Tube

- ◆ Ensure that the vertical stem of the T is fully inside the insertion tube (Figure C1, arrow).
- ◆ Ensure that the other end of the insertion tube (farthest from the IUCD) is close to the sealed end of the package.

Figure C-1 Vertical Stem of T fully inside Insertion Tube

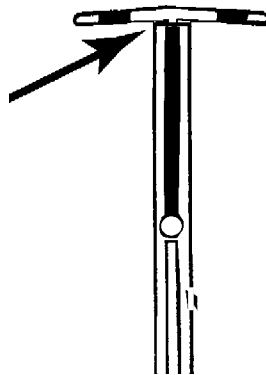

STEP 2: Partially open the package:

- ◆ Place the package on a clean, hard, flat surface with the clear plastic side up.
- ◆ Pull up on the clear plastic cover from the end that is farthest from the IUCD (marked OPEN).
- ◆ Keep pulling the plastic cover until the package is open approximately half way to the blue length-gauge.

STEP 3: Place the white plunger rod in the clear insertion tube:

- ◆ Pick up the package, holding the open end up toward the ceiling so that the contents do not fall out.
- ◆ Starting at the open end of the package, fold the clear plastic cover and white backing “flaps” away from each other (as shown in Figure C-2a).
- ◆ Using your free hand, grasp the white plunger rod (behind the measurement insert) by the circular thumb grip and remove it from the package.

Do not touch the tip of the white plunger rod or brush it against another surface, as this will cause it to lose its sterility.

- ◆ Place the plunger rod inside the insertion tube (Figure C-2a) and gently push until the tip of the rod almost touches the bottom of the T (Figure C-2b, arrow).

Figure C-2a. Placing White Plunger

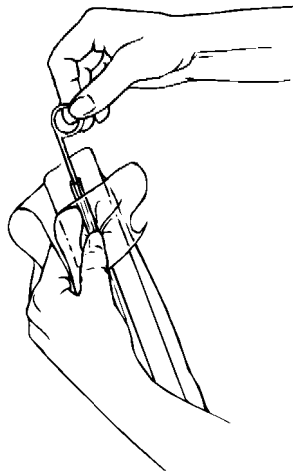
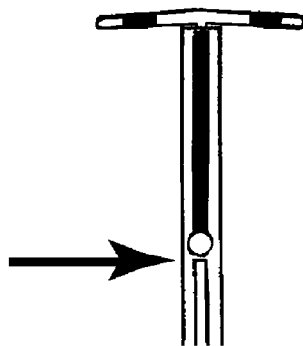

Figure C-2b. Plunger Rod alMost Rod inside Insertion Touching Bottom of T Tube



STEP 4: Bend the “arms” of the “T” downward:

Do not bend the arms of the T into the insertion tube for more than 5 minutes before it is introduced into the uterus.

- ◆ Release the white backing flap so that it is flat again, and place the package back on the clean, hard, flat surface with the clear plastic side up.
- ◆ Through the clear plastic cover, place your thumb and index finger over the tips of the horizontal arms of the T to stabilize the IUCD (Figure C-3, open arrow).

Figure C-3 Positioning IUCD and Bending Arms of T

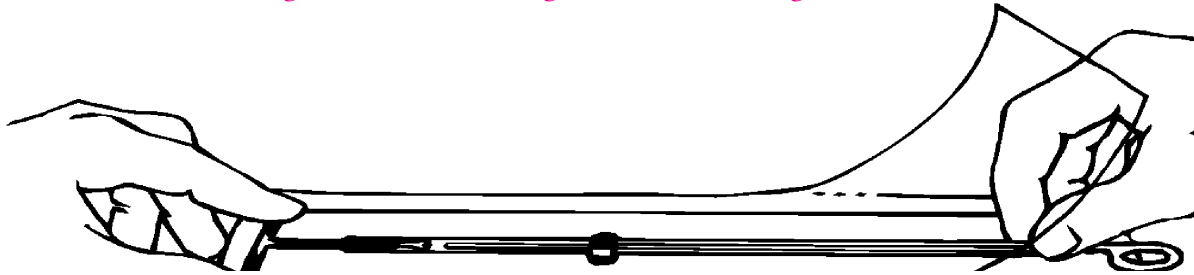

- ◆ At the open end of the package, use your free hand to push the measurement insert so that it slides underneath the IUCD and stops at the sealed end of the package.
- ◆ Still holding the tips of the arms of the T, use your free hand to grasp the insertion tube and gently push it against the T (Figure C-3, solid arrow). This pressure will cause the arms to begin bending downward, toward the stem of the T (as shown on the measurement insert).
- ◆ Finish bending the arms of the T by bringing your thumb and index finger together, and continuing to push against the T with the insertion tube.

STEP 5: Pull the insertion tube away from folded arms of the T: When the arms of the T are folded down enough to touch the sides of the insertion tube, pull the insertion tube out from between the arms.

STEP 6: Push the folded arms of the T into the insertion tube:

- ◆ Gently push and rotate the insertion tube back over the tips of the folded arms of the T, so that both tips are caught inside the insertion tube (Figure C-4, Upper image). (As you maneuver the tips of the arms into the opening of the tube, it may help to slightly elevate the other end of the tube.)
- ◆ Push the folded arms of the IUCD into the insertion tube only as far as necessary to keep them fixed in the tube (Figure C.4, Lower image). Do not try to push the copper bands on the arms into the insertion tube, as they will not fit.

Figure C.4 Inserting Folded IUCD Arms into Insertion

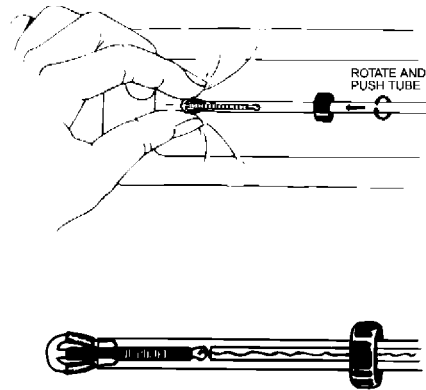

STEP 7: Set the blue length-gauge to the appropriate measurement: With the loaded IUCD still in the partially unopened package, set the blue length-gauge to the corresponding measurement obtained from sounding the uterus:

- ◆ Move the length-gauge so that its inside edge (the edge closest to the IUCD) is aligned with the appropriate centimeter mark on the measurement insert (e.g., 6 cm, 7.5 cm, 8 cm).
- ◆ Press down on the length-gauge with the thumb and index finger of one hand to keep it in place, while sliding the insertion tube with your other hand until the tip of the IUCD (the top of the folded T) aligns with the tip in the diagram on the measurement insert. This is the “0” centimeter mark.
- ◆ Ensure that the distance between tip of the IUCD and the inside edge of the length-gauge is equal to the length of the uterus as determined by uterine sounding (Figure C-5).

Figure C-5 Using blue length-gauge to set length of uterus on insertion tube

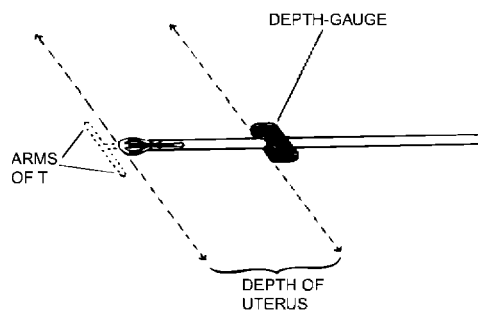

STEP 8: Align the length-gauge and the folded arms of the T so that they are both in a “horizontal” position (i.e., flat against the measurement insert).

STEP 9: Remove the loaded IUCD from the package:

- ◆ Finish peeling back the clear plastic cover from the white backing in one brisk, continuous movement with one hand, while holding the insertion assembly down against the white backing on the table (at the open end of the package) with the other hand.
- ◆ Lift the loaded IUCD from the packaging, keeping it level so that the T and white plunger rod do not fall out (Figure C.6). Be careful not to push the white rod toward the T, as this will release the IUCD from the insertion tube.

Do not let the IUCD or IUCD insertion assembly touch any non-sterile surfaces that may contaminate it.

Figure C.6 IUCD fully loaded in insertion tube

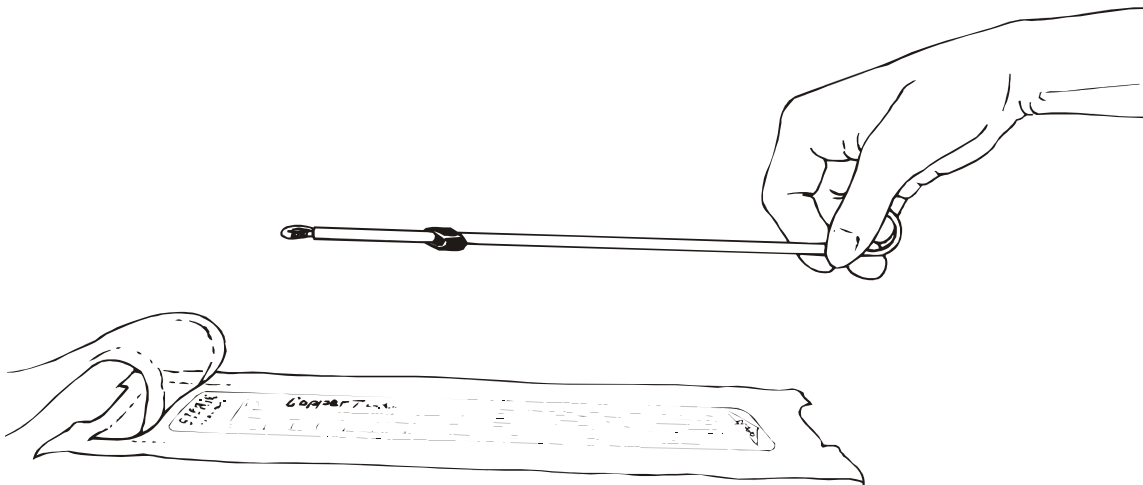

You are now ready to insert the IUCD, as instructed in Chapter 6

Annexure 9

Key messages for women who have just had an IUCD inserted

TOPIC	MESSAGES
<p>Basic facts about your IUCD</p>	<ul style="list-style-type: none"> ◆ You have Copper T IUCD and It should be replaced in 10 years, but you can come back to have it removed for any reason whenever you wish. ◆ It is effective immediately. You can have sexual intercourse as soon as you desire. ◆ Keep the IUCD card and take it with you when you visit any healthcare facility for any reason.
<p>No protection against STIs</p>	<ul style="list-style-type: none"> ◆ The IUCD provides no protection against HIV or other STIs. ◆ If you think you or your partner could be at risk for exposure to HIV or other STIs, you should use a condom for protection every time you have sex. ◆ Feel free to bring your partner to the clinic to further discuss this issue at any time.
<p>Possible side effects</p> <p>Important: Be clear about the possibility of menstrual changes with the IUCD. If the woman knows what to expect, she is more likely to be satisfied with her choice and less likely to worry about side effects if they occur.</p>	<ul style="list-style-type: none"> ◆ You may experience pain, light bleeding, and/or cramps immediately after IUCD insertion. The cramping may last for a few days. ◆ Many women experience heavier bleeding, longer bleeding, and or more cramping than usual during their menstrual periods, and or spotting between their periods. These symptoms usually lessen or go away within the first few months after IUCD insertion. ◆ Generally, these symptoms are not harmful and do not indicate a problem. ◆ Return to the clinic if these symptoms become bothersome. ◆ If you experience bleeding that is twice as long or twice as heavy as usual, return to the clinic immediately.

TOPIC	MESSAGES
Warning signs (PAINS)	<ul style="list-style-type: none"> ◆ The following signs/symptoms (which spell the word PAINS) are warning signs for IUCD users and may indicate a serious problem: <ul style="list-style-type: none"> P: Period-related problems or pregnancy symptoms A: Abdominal pain or pain during intercourse I: Infections or unusual vaginal discharge N: Not feeling well, fever, chills S: String problems ◆ If you experience any of these warning signs (or PAINS), return to the clinic immediately.
<p>Checking for possible IUCD expulsion</p> <p>New Thinking about Checking IUCD Strings: IUCD expulsion is uncommon, and undetected IUCD expulsion is rare. Thus, unless the IUCD was inserted immediately after childbirth or a second-trimester abortion the provider should minimize this aspect of counseling and focus more on the other messages.</p>	<p>If IUCD was inserted immediately after childbirth or a second trimester abortion tell the woman the following,</p> <ul style="list-style-type: none"> ◆ IUCD expulsion is most likely to occur within the first few months after IUCD insertion (especially during menstruation). ◆ Check your strings occasionally during the first few months after IUCD insertion (preferably after your menstrual period). ◆ Check your menstrual cloth/pad/tampon and the latrine for an expelled IUCD during your first few menstrual periods. ◆ If you can not feel your IUCD strings or suspect that your IUCD has been expelled, begin using a back-up contraceptive method and return to the clinic immediately.
When to return to the clinic	<p>What you should know and do:</p> <ul style="list-style-type: none"> ◆ “A single routine checkup is recommended after your first post-insertion menstrual period (3 to 6 weeks) but not later than 3 months after insertion.” ◆ “You should return immediately if you experience warning signs (PAINS).” ◆ “You CAN return at any point (days, months, years) if you want the IUCD removed, there are changes in your reproductive goals or overall health, or you suspect STI exposure.” ◆ “You should return in 10 years to have your IUCD removed/replaced.” ◆ “You CAN return if you have any problems or concerns, or for any reason at all.”

Preparing and Using Chemical Disinfectants*

Chemicals for Sterilization and/or High-Level Disinfection										
Disinfectant (common solution or brand)	Effective Concentration	How to Dilute	Skin Irritant	Eye Irritant	Respiratory Irritant	Corrosive	Leaves Residue	Time Needed for HLD	Time Needed for Sterilization	Activated Shelf Life ^a
Chlorine	0.1%	Dilution procedures vary by brand	Yes (with prolonged contact)	Yes	Yes	Yes ^c	Yes	20 minutes	Do not use	Change every 14 days, sooner if cloudy.
Glutaraldehyde	Varies (2–4%)	Add activator	Yes	Yes (vapors)	Yes	No	Yes	20 minutes at 25°C ^d	10 hours for Cidex	Change every 14–28 days, sooner if cloudy.
CHEMICALS FOR DISINFECTION (Note: alcohols and iodophors are not high-level disinfectants.)										
Alcohol (ethyl or isopropyl)	60–90%	Use full strength	Yes (can dry skin)	Yes	No	No	No	Do not use	Do not use	If container (bottle) kept closed, use until empty.
Iodophors (10% povidone iodine [PVI])	Approximately 2.5%	1 part 10% PVI to 3 parts water	No	Yes	No	Yes	Yes	Do not use	Do not use	If container (bottle) kept closed, use until empty.

^a All chemical disinfectants are heat- and light-sensitive and should be stored away from direct sunlight and in a cool place (< 40°C).

^b See Table A-1 for instructions on preparing chlorine solutions.

^c Corrosive with prolonged (> 20 minutes) contact at concentrations > 0.5% if not rinsed immediately with boiled water.

^d Different commercial preparations of Cidex and other glutaraldehydes are effective at lower temperatures (20°C) and for longer activated shelf life. Always check manufacturers' instructions.

* Adapted from: Rutala 1996.

Annexure 10 B

Making a Dilute Chlorine Solution (0.5%) for Decontamination

Using Liquid Bleach

1 part bleach to 9 parts water (use the same container to measure the bleach and water)

Step 1



Step 2



Step 3



Using Dry Chlorine Powder

Formulas

70% concentrated powder = 7 grams per 1 liter of water

35% concentrated powder = 14 grams per 1 liter of water

Step 1

Measure dry powder and water based on formulas

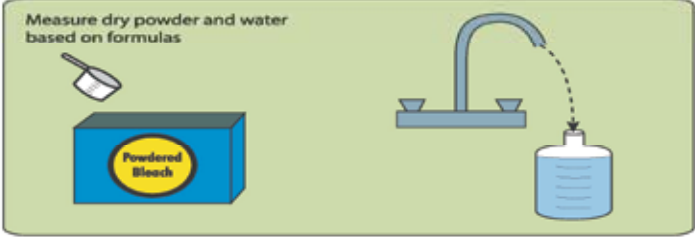

Step 2

Measured amount of dry powder



Step 3

Add water and mix until powder is dissolved

1 part to measured amount of water



Step 4

Add rest of water and mix

Measured amount of water



Steps in Processing Instruments, Gloves, and other items used in IUCD Services*

Instruments/Item	Decontamination (Decontamination is the first step in handling dirty instruments; reduces risk of HBV and HIV transmission.)	Cleaning (Cleaning removes all visible blood, body fluids, and dirt.)	HLDa (Recommended method of final-processing; HLD destroys all viruses, bacteria, parasites, fungi, and some endospores.)	Sterilizationb (Alternative method of final-processing; sterilization destroys all microorganisms, including endospores.)
Examination table top and other large surface areas	Wipe off with 0.5% chlorine solution.	Wash with soap and water if organic material remains after decontamination.	Not necessary.	Not necessary.
Surgical gloves	Soak in 0.5% chlorine solution for 10 minutes before cleaning. Rinse or wash immediately.c	Wash with soap and water. Rinse with clean water and check for holes. If to be sterilized, dry inside and out (air or towel dry) and package.	Stream for 20 minutes and allow to air dry in steamer for 4 to 6 hours.	<ul style="list-style-type: none"> ◆ Autoclave at 121°C (250°F), and 106 kPa (15 lbs/in²) for 20 minutes. ◆ Do not use for 24 to 48 hours.
Instruments used in pelvic exam and IUCD insertion or removal (e.g., speculum, volselum, forceps, uterine sound)	Soak in 0.5% chlorine solution for 10 minutes before cleaning. Rinse or wash immediately.c	Using a brush, wash with soap and water. Rinse with clean water. If they will be sterilized, air or towel dry and package.	<ul style="list-style-type: none"> ◆ Steam or boil for 20 minutes. ◆ Chemically high-level disinfect by soaking for 20 minutes. Rinse well with boiled water and air dry before use or storage. 	<ul style="list-style-type: none"> ◆ Dry heat for 1 hour after reaching 170°C (340°F), or ◆ Autoclave at 121°C (250°F) and 106 kPa (15 lbs/in²) for 20 minutes (30 minutes if wrapped).
Storage containers for instruments	Soak in 0.5% chlorine solution for 10 minutes before cleaning. Rinse or wash immediately.b	Wash with soap and water. Rinse with clean water, air or towel dry.	<ul style="list-style-type: none"> ◆ Boil container and lid for 20 minutes. If container is too large: <ul style="list-style-type: none"> ◆ Fill container with 0.5% chlorine solution and soak for 20 minutes. ◆ Rinse with water that has been boiled for 20 minutes and air dry before use. 	<ul style="list-style-type: none"> ◆ Dry heat for 1 hour after reaching 170°C (340°F), or ◆ Autoclave at 121°C (250°F) and 106 kPa (15 lbs/in²) for 20 minutes (30 minutes if wrapped).

^a In the context of IUCD services, HLD (as opposed to sterilization) is the recommended method of final-processing.

^b If unwrapped, use immediately; if wrapped, may be stored up to 1 week before use.

^c Avoid prolonged exposure (More than 20 minutes) to chlorine solution (More than 0.5%) to minimize corrosion of instruments and deterioration of rubber or cloth products.

* Adapted from: Perkins 1983.

Annexure 11

IUCD (380 A) follow up card

Name of Centre _____ S. No. _____

Name:

Age (years):

Husband's name:

Address:

Contact no.(if any):

Obstetric status: LMP _____ LCB _____

Date of insertion:

S No.	Date	Remarks	Name/Signature of staff
1ST visit			
2			
3			
4			
5			
6			
7			
8			
9			
10			

Date of removal:

Reason for removal: desire for pregnancy/ pain/ bleeding/ others

References

1. *IUD guidelines for Family Planning Service Programme*, by JHPIEGO
2. *Medical Eligibility Criteria for Contraceptive Use* (2004), World Health Organization, Geneva.
3. *Guidelines for IUCD insertion for Medical Officers*, by Ministry of Health and Family Welfare, Government of India, New Delhi 2003
4. *Standards for female and male sterilization services*, by Ministry of Health and Family Welfare, Government of India, New Delhi 2006
5. *National guidelines on Prevention, Management and Control of RTI including STI* by NACO and MH division, Government of India, New Delhi November 2006

List of Experts

1.	Dr. Alok Banerjee Parivar Seva Sansthan B.804-Parijat Apartments Sector-4,Dwaraka N.Delhi.75 Ph.25094224@ 9810503707 alokbanerjee@gmail.com
2.	Dr. Anita Mehndiratta I/C PP unit GTB Hospital, Delhi 22586262 ext. 216 Fax 22581928 drgracem@gmail.com
3.	Mrs. Anjana Dhall Principal School of Nursing, School of Nursing GTB hospital Dilshad Garden, Delhi – 95 Ph.22586262 anjanadhall@yahoo.com
4.	Ms. Antigoni Koumpounisa, STP and SRH WHO , India country office Nirman bhavan N.Delhi -11 Ph.23061955 koumpounisa,@searo.who.int
5.	Dr. Arvind Mathur National professional Officer WHO , India country office Nirman bhavan N.Delhi 11 Ph.23061955 mathura@searo.who.int
6.	Dr. Chandrakant Ruparelia HIV/AIDS Advisor JHPIEGO, Baltimore USA cruparelia@jhpiego.net

7.	Dr. Daya Krishan Mangal Advisor (RH), UNFPA, 53, Jorbagh N. Delhi-3 09425301998 mangal@unfpa.org
8.	Sri. Dileep Kumar, Nursing Advisor, DGHS Nirman Bhavan N.Delhi-01 Ph.23062726 @ 26267144
9.	Dr. Dinesh Agarwal, Technical Advisor,RH UNFPA 53,Jorbagh New Delhi-03 agarwal@unfpa.org
10.	Dr. K. Kalaivani, Professor,Nodal officer-RCH Dept of RBM NIHFW,Munirka-067 N.Delhi Ph.26165959 kalaivanikrishnamurthy@gmail.com
11.	Dr. Kamal Hazari, Deputy Director National Institute for Research in Reproductive Health (ICMR) JM Street, Parel, Mumbai 400012 Ph.24192000& 24192030-022 dirirra@rediffmail.com
12.	Dr. Loveleen Johri Sr. Rep. Advisor USAID,American Embassy Chankyapuri Ph.24198412 ljohri@usaid.gov
13.	Dr. Malavika Roy, DDG, Division of RHN, ICMR, N.Delhi Ph.26588713& 9810469893 malaroyba@yahoo.com

14.	Dr. Manjula, Sr. Splecialist., Safdurjang Hospital, N.Delhi.24 Ph.26198108
15.	Dr. Milind Shah Gynaecologist, FOGSI 199,S.Korba Solapur.7 Ph.0217-2318531
16.	Ms. Monique Mosolf Chief, RH Division USAID American Embassy Chankyapuri Ph.24198633 mmosolf@usaid.gov
17.	Prof. (Dr.) Mumtaz Sanghamita Senior Consultant (Med), RCH Div. NIHFW Munirka, Delhi Ph.26160156
18.	Dr. N. Namshum, Deputy Commissioner (Training), MOHFW,Nirman Bhavan, N.Delhi-01 Ph.23062791 n_namshun@yahoo.com
19.	Dr. Nayara Shakeel Joint,Dr(RCH), DGFW, Jagat narain road,Lucknow Uttar Pradesh Ph.9839011534 nayarashakeel@yahoo.com
20.	Dr. Nidhi Chaudhary Senior Programme Specialist Constella Futures group Parkwood estate Rau Tula Ram Marg N.Delhi. Ph. 26712165 nchaudhary@constellagroup.com
21.	Dr. Nisha Gupta FHAI 16,Sundernagar N.Delhi M.9871484626 nishagupta@gmail.com

22.	Dr. Pankaj Desai, President, FOGSI, Kama&Albless Hospital',Mahapalika marg Mumbai 400001 Ph.0265-2437793 pankajdesai@gmail.com
23.	Dr. Pikee Saxena Gynaecologist,Lecturer RBM Dept NIHFW N.Delhi Ph.26160156 pikesaxena@hotmail.com
24.	Dr. Puneeta Mahajan Specialist (OBG), Sanjay Gandhi Memorial Hospital, New Delhi Ph.2792117 R-25430543 puneetamahajan@redifmail.com
25.	Dr. Renu Shahrawat Gynaecologist Lecturer, RBM Dept NIHFW N.Delhi Ph.26160156 renushahrawat@hotmail.com
26.	Dr. S. Menon, Reader, RBM Asst. Nodal officer (RCH II) NIHFW Munirka, Delhi Ph.26160156 smenon30@gmail.com
27.	Mrs. Santosh Yadav Supt. Lady Reading Health School Delhi M.9811623346
28.	Mrs. Sarita , TUTOR R.A.K. College of Nursing Lajpat Nagar New Delhi M.9810911986

29.	Dr. Sonia Trikha Consultant, WHO , India country office Nirman bhavan N.Delhi –11 Ph.23061955
30.	Dr. Sudha Salhan HOD, O&G Safdarjung Hosp. N.Delhi.-24 Ph.26198108 sudha_salhan@yahoo.co.in
31.	Prof. Suneeta Mittal Head of. Dept. of Obst. & Gynae AIIMS N.Delhi Ph.26593378,26588449-(M) 9818542111 suneeta_mittal@gmail.com
32.	Dr. Sunita Singal CMO (NFSG), Dept of Obst & Gynae VMMC of Safdarjung Hospital, New Delhi Ph.26198108 (R)29212656 drsunitasingal@gmail.com
33.	Dr. Keerti Malaviya AC,FP Div MOHFW,Nirman Bhavan N.Delhi -1 Ph.23061089
34.	Dr. Jaya Lalmohan Consultant, FP Div.MoHFW Nirman Bhavan N.Delhi-1 Ph.23062485 @ 24102112 jayalalmohan@gmail.com
35.	Dr. Sonali Consultant FP Div.MOHFW Nirman Bhavan N.Delhi-1 Ph. 23062485 sonsam72@yahoo.co.uk
36.	Dr. M.S Jayalakshmi DC,FP Division Room.No311,D Wing MOHFW,Nirman Bhavan N.Delhi-1 Ph. 23062485 jaya.ms@nb.nic.in

37.	Dr. Sikdar S.K. AC,FP Div Room.No.452 A wing MOHFW,Nirman Bhavan N.Delhi-1 Ph.23062427 sk.sikdar@nic.in
-----	---